



Drilling Tools

Hydraulic
Rotary Rig

BUCKETS
AUGERS
ROCK AUGERS
UNDERREAMERS
CHISELS
CORE BARRELS

Drilling Tools

soilmec®
Drilling and Foundation Equipment

Drilling Tools

A new model

Selecting the correct cutting tool is a complicated decision that any piling Contractor will face on every job in order to complete it on time and, therefore, the use of an appropriate tool capable of achieving the overall expected productivity level is vital.

Soilmec has become a worldwide reference point based on over four decades of experience providing appropriate solutions in the underground engineering sector.

Soilmec drilling tools are the result of years of research, investigation and innovation in the mechanical excavation sector. Collecting data from different job sites, testing our tools in different soil conditions and studying the performance in environments varying from very soft soils to the most difficult geological conditions, understanding Clients needs and verifying performances, has positioned Soilmec as one of the most cost effective tools available on the market.



When time is of the essence, the High Quality steel used on our tools, the robust welding, accurate finishing and their durability have made our products the best available on the market.



Automated Teeth Positioning System

Drilling tools teeth alignment and assembling accuracy is imperative. Soilmec has introduced an Automatic Tooth Positioning where man errors or inaccuracies are avoided by a computerized assembling system. This sophisticated mechanical process guarantee accurateness, effectiveness and product Quality.



Soilmec drilling tool range includes general purpose Augers, boring Buckets, cleaning Buckets and core barrels amongst others. Standard Soilmec drilling tools range from small to large borehole diameters (400 mm - 2000 mm), and offer the possibility to mount Kelly box size 130x130 mm, 150x150 mm and 200x200 mm.

Soilmec provides with complete drilling tools range which includes both standard drilling tools and customized drilling tools.

For an easy Soilmec drilling tools selection on this catalogue, our drilling tools has been divided between "coarse - cohesive soil" applications and "rock soil" applications.

Additionally and as a general guide, it has been proposed two matrix, first one for Coarse and Cohesive soils while the second one for Rock soils formation. On both of them it has been indicated Soilmec drilling tools expected range of application.

Coarse - Cohesive Soil

USCS (ASTM D-2487) Soil Description					Drilling Tool			
					BUCKET	AUGER	CORE BARREL	
Coarse Grained Soils	Gravels > 50% of coarse fraction retained on N°4 sieve	Clean Gravels	GW	33°-45° 0 KPa	Well-graded gravels and gravel-sand mixtures, little or no fines	SSB-GH25 SSB-GCL25	<i>Not recommended*</i>	<i>Not recommended**</i>
			GP	33°-45° 0 KPa	Well-graded gravels and gravel-sand mixtures, little or no fines	SSB-GH25 SSB-GCL25	<i>Not recommended*</i>	<i>Not recommended**</i>
		Gravel with Fines	GM	30°-40° 0 KPa	Silty gravels, gravel-sand-silt mixtures.> 12% fines	SSB-GH25 SSB-GCL25	<i>Not recommended*</i>	<i>Not recommended**</i>
			GC	30°-40° 0 KPa	Clayey gravels, gravel-sand-clay mixtures.>12% fines	SSB-GH25 SSB-GCL25	<i>Not recommended*</i>	<i>Not recommended**</i>
	Sands ≥50% of coarse fraction retained on N°4 sieve	Clean Sands	SW	30°-40° 0 KPa	Well grade sand, fine to coarse sand	SSB-G25 • SSB-GH25 SSB-LW30 • SSB-GCL25	<i>Not recommended*</i>	<i>Not recommended**</i>
			SP	30°-40° 0 KPa	Poorly-graded sand	SSB-G25 • SSB-GH25 SSB-LW30 • SSB-GCL25	<i>Not recommended*</i>	<i>Not recommended**</i>
		Sands with Fines	SM	28°-35° 0 KPa	Silty sand, sand-silt mixtures	SSB-H05 • SSB-G25 SSB-GH25 • SSB-LW30 SSB-CN60-SSB-GCL25	SSA-H30 SSA-H35 SSA-H36	<i>Not recommended**</i>
			SC	28°-35° 0 KPa	Clayey sands, sand-clay mixtures	SSB-H05 • SSB-G25 SSB-GH25 • SSB-LW30 SSB-CN60 • SSB-GCL25	SSA-H30 SSA-H35 SSA-H36	<i>Not recommended**</i>
Fine Grained Soils	Silts and Clays liquid limit (LL)< 50	ML	0-200 KPa	Inorganic silts, very fine sands, rock flour, silty or clayey fine sands	SSB-05 • SSB-H05 SSB-LW30 • SSB-CN60 SSB-CL05	SSA-40 • SSA-H30 SSA-H35 SSA-H36	<i>Not recommended**</i>	
		CL	0-300 KPa	Inorganic clays of low to medium plasticity, gravelly/sandy/silty /lean clays	SSB-05 • SSB-H05 SSB-LW30 • SSB-CN60 SSB-CL05	SSA-40 • SSA-H30 SSA-H35 SSA-H36	<i>Not recommended**</i>	
		OL	0-200 KPa	Organic silts and organic silty clays of low plasticity	SSB-05 • SSB-H05 SSB-LW30 • SSB-CN60 SSB-CL05	SSA-40 • SSA-H30 SSA-H35 SSA-H36	<i>Not recommended**</i>	
	Silts and Clays liquid limit (LL)≥ 50	MH	0-20 KPa	Silt of high plasticity, elastic silt	SSB-05•SSB-H05•SSB-LW30 SSB-CN60 • SSB-H01 SSB-CL05 • SSB-SP00	SSA-40 • SSA-H30 SSA-H31 • SSA-H35 SSA-H36	<i>Not recommended**</i>	
		CH	0-200 KPa	Clay of high plasticity, fat clay	SSB-05•SSB-H05•SSB-LW30 SSB-CN60 • SSB-H01 SSB-CL05 • SSB-SP00	SSA-40 • SSA-H30 SSA-H31 • SSA-H35 SSA-H36	<i>Not recommended**</i>	
		OH	0-10 KPa	Organic clay, organic silt	SSB-05•SSB-H05•SSB-LW30 SSB-CN60 • SSB-H01 SSB-CL05 • SSB-SP00	SSA-40 • SSA-H30 SSA-H31 • SSA-H35 SSA-H36	<i>Not recommended**</i>	
Highly Organic Soils	Pt	0-10 KPa	Peat muck and other highly organics soils	SSB-05•SSB-H05•SSB-LW30 SSB-CN60 • SSB-H01 SSB-CL05 • SSB-SP00	SSA-40 • SSA-H30 SSA-H31 • SSA-H35 SSA-H36	<i>Not recommended**</i>		

Prefix: **G** = Gravel, **S** = Sand, **M** = Silt, **C** = Clay, **O** = Organic - Suffix: **W** = Well Graded, **P** = Poorly Graded, **M** = Silty, **L** = Clay, **LL** < 50 %, **H** = Caly, **LL** > 50%

* In cohesionless materials, Auger may not have expected productivity because soil material will not stay on the Auger flights during extraction.

** Not able to extract soil material from drilled hole. Backup tool in case of Boulders presence.

AUGERS

SSA - 40 (Auger)

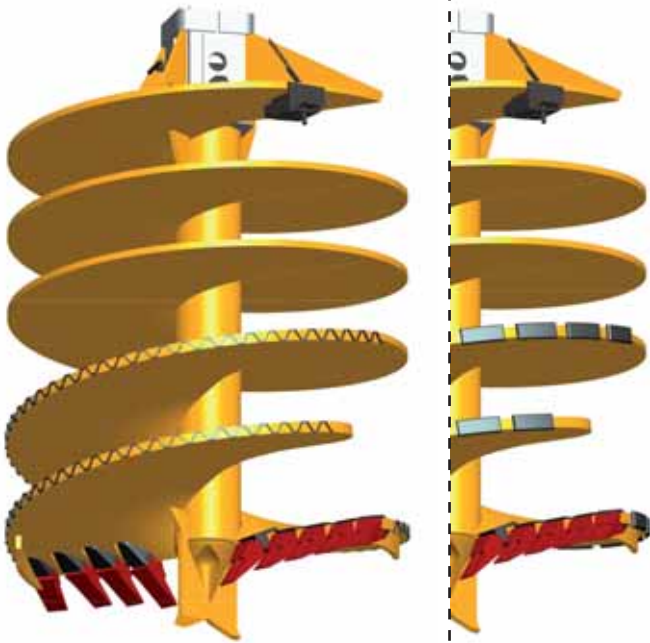

M type

D type

AUGER for fine grained and organic soils like silty or clayey fine sands, organic/inorganic silts; high/medium/low plasticity clays; fat clays; peat; muck.
USCS soils: **ML, CL, OL, MH, CH, OH, Pt** .

Teeth: *Flat ESCO Super V*
Nom. length: 1310 mm (Ø 400 mm) - 1410 mm (Ø 500/600 mm)
1550 mm (from Ø 700 to 1200 mm)

Ø	PART N°			Approx. Weight (kg)
	Kelly Box 130 x 130 mm	150 x 150 mm	200 x 200 mm	
400	(M/D) Z040140W	(M/D) Z040140X	-	250
500	(M/D) Z050140W	(M/D) Z050140X	-	300
600	(M/D) Z060140W	(M/D) Z060140X	(M/D) Z060140Z	360
700	(M/D) Z070140W	(M/D) Z070140X	(M/D) Z070140Z	420
800	(M/D) Z080140W	(M/D) Z080140X	(M/D) Z080140Z	475
900	(M/D) Z090140W	(M/D) Z090140X	(M/D) Z090140Z	530
1000	(M/D) Z100140W	(M/D) Z100140X	(M/D) Z100140Z	670
1100	(M/D) Z110140W	(M/D) Z110140X	(M/D) Z110140Z	720
1200	(M/D) Z120140W	(M/D) Z120140X	(M/D) Z120140Z	815

SSA - H30 (Heavy Duty Auger)

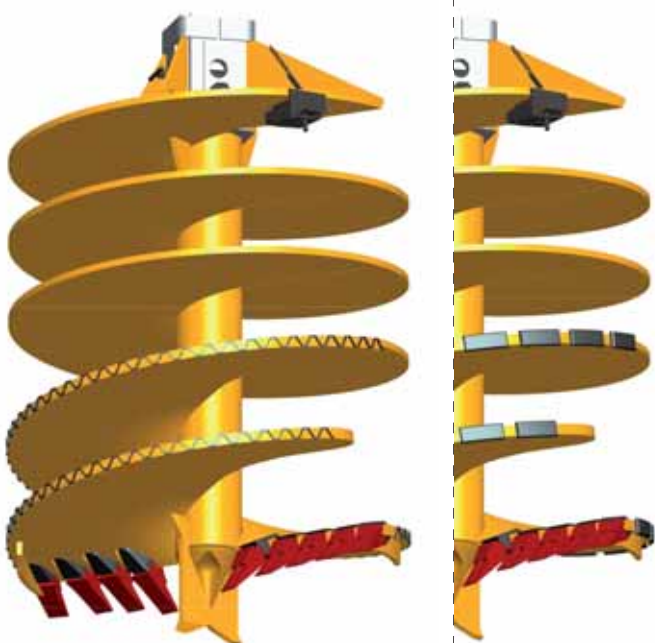

M type

D type

Heavy Duty AUGER for sand with fines, fine grained and organic soils like silty sands, sand-silt mixtures, clayey sand, sand-clay mixtures, organic and inorganic silts; high/medium/low plasticity clays; fat clays; peat; muck.

USCS soils: **SM, SC, ML, CL, OL, MH, CH, OH, Pt**.

Teeth: *Flat ESCO Super V*
Nom. length: 2350 mm (Ø 400 or 500 mm)
2150 mm (Ø 600 to 1000 mm)
2000 mm (from Ø 1100 to 1400 mm)
1700 mm (from Ø 1500 to 2000 mm)

Ø	PART N°			Approx. Weight (kg)
	Kelly Box 130 x 130 mm	150 x 150 mm	200 x 200 mm	
400	(M/D) H040130W	(M/D) H040130X	-	375
500	(M/D) H050130W	(M/D) H050130X	-	460
600	(M/D) H060130W	(M/D) H060130X	(M/D) H060130Z	510
700	(M/D) H070130W	(M/D) H070130X	(M/D) H070130Z	625
800	(M/D) H080130W	(M/D) H080130X	(M/D) H080130Z	745
900	(M/D) H090130W	(M/D) H090130X	(M/D) H090130Z	875
1000	(M/D) H100130W	(M/D) H100130X	(M/D) H100130Z	1040
1100	(M/D) H110130W	(M/D) H110130X	(M/D) H110130Z	1125
1200	(M/D) H120130W	(M/D) H120130X	(M/D) H120130Z	1295
1300	(M/D) H130130W	(M/D) H130130X	(M/D) H130130Z	1475
1400	(M/D) H140130W	(M/D) H140130X	(M/D) H140130Z	1685
1500	(M/D) H150130W	(M/D) H150130X	(M/D) H150130Z	1340
1600	(M/D) H160130W	(M/D) H160130X	(M/D) H160130Z	1485
1700	(M/D) H170130W	(M/D) H170130X	(M/D) H170130Z	1645
1800	(M/D) H180130W	(M/D) H180130X	(M/D) H180130Z	1810
1900	(M/D) H190130W	(M/D) H190130X	(M/D) H190130Z	1985
2000	(M/D) H200130W	(M/D) H200130X	(M/D) H200130Z	2170

SSA - H31 (Double Blade Auger)

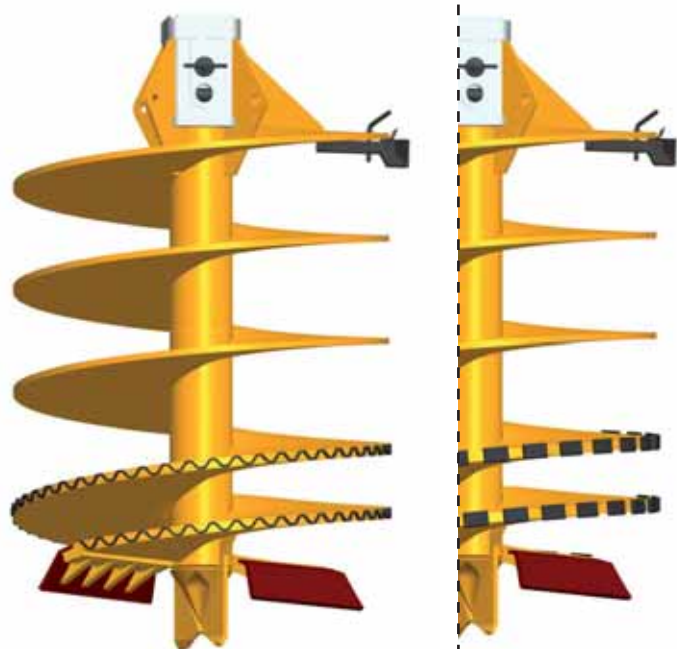

M type

D type

AUGER for highly organic soil; high/medium plasticity clays; fat clays; peat; muck.

USCS soils: **MH, CH, OH, Pt** .

Teeth: *Hardox Blade*
 Nom. length: 2350 mm (Ø 400 or 500 mm).
 2150 mm (Ø 600 or 1000 mm)
 2000 mm (from Ø 1100 to 1400 mm)
 1700 mm (from Ø 1500 to 2000 mm)

Ø	Kelly Box	PART N°			Approx. Weight (kg)
		130 x 130 mm	150 x 150 mm	200 x 200 mm	
400	(M/D)	H040131W	(M/D) H040131X	-	375
500	(M/D)	H050131W	(M/D) H050131X	-	460
600	(M/D)	H060131W	(M/D) H060131X	(M/D) H060131Z	510
700	(M/D)	H070131W	(M/D) H070131X	(M/D) H070131Z	625
800	(M/D)	H080131W	(M/D) H080131X	(M/D) H080131Z	745
900	(M/D)	H090131W	(M/D) H090131X	(M/D) H090131Z	875
1000	(M/D)	H100131W	(M/D) H100131X	(M/D) H100131Z	1040
1100	(M/D)	H110131W	(M/D) H110131X	(M/D) H110131Z	1125
1200	(M/D)	H120131W	(M/D) H120131X	(M/D) H120131Z	1295
1300	(M/D)	H130131W	(M/D) H130131X	(M/D) H130131Z	1475
1400	(M/D)	H140131W	(M/D) H140131X	(M/D) H140131Z	1685
1500	(M/D)	H150131W	(M/D) H150131X	(M/D) H150131Z	1340
1600	(M/D)	H160131W	(M/D) H160131X	(M/D) H160131Z	1485
1700	(M/D)	H170131W	(M/D) H170131X	(M/D) H170131Z	1645
1800	(M/D)	H180131W	(M/D) H180131X	(M/D) H180131Z	1810
1900	(M/D)	H190131W	(M/D) H190131X	(M/D) H190131Z	1985
2000	(M/D)	H200131W	(M/D) H200131X	(M/D) H200131Z	2170

SSA - H35 (Heavy Duty - Double Start Hard Soil Auger)

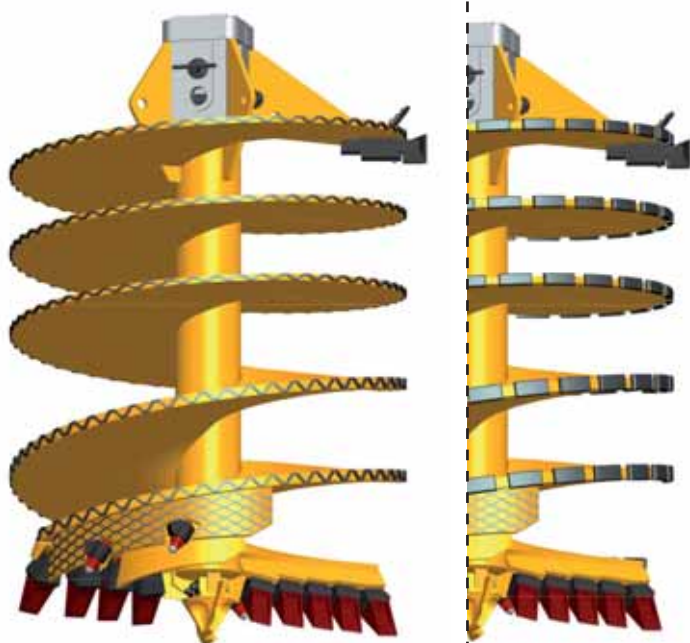

M type

D type

Heavy Duty AUGER for cobbles with sand and fines, cobbles with fine grained and organic soils like silty sands, sand-silt mixtures, clayey sand, sand-clay mixtures, organic and inorganic silts; cobbles with high/medium/low plasticity clays; cobbles with fat clays; cobbles with peat; cobbles with muck.

USCS soils: **SM, SC, ML, CL, OL, MH, CH, OH, Pt**.

Teeth: *Flat pick with TC inset & round pick 30 mm shank*
 Nom. length: 2350 mm (Ø 400 or 500 mm).
 2150 mm (Ø 600 or 1000 mm)
 2000 mm (from Ø 1100 to 1400 mm)
 1700 mm (from Ø 1500 to 2000 mm)

Ø	Kelly Box	PART N°			Approx. Weight (kg)
		130 x 130 mm	150 x 150 mm	200 x 200 mm	
400	(M/D)	H040135W	(M/D) H040135X	-	575
500	(M/D)	H050135W	(M/D) H050135X	-	660
600	(M/D)	H060135W	(M/D) H060135X	(M/D) H060135Z	710
700	(M/D)	H070135W	(M/D) H070135X	(M/D) H070135Z	825
800	(M/D)	H080135W	(M/D) H080135X	(M/D) H080135Z	945
900	(M/D)	H090135W	(M/D) H090135X	(M/D) H090135Z	1075
1000	(M/D)	H100135W	(M/D) H100135X	(M/D) H100135Z	1240
1100	(M/D)	H110135W	(M/D) H110135X	(M/D) H110135Z	1325
1200	(M/D)	H120135W	(M/D) H120135X	(M/D) H120135Z	1595
1300	(M/D)	H130135W	(M/D) H130135X	(M/D) H130135Z	1675
1400	(M/D)	H140135W	(M/D) H140135X	(M/D) H140135Z	1885
1500	(M/D)	H150135W	(M/D) H150135X	(M/D) H150135Z	1540
1600	(M/D)	H160135W	(M/D) H160135X	(M/D) H160135Z	1685
1700	(M/D)	H170135W	(M/D) H170135X	(M/D) H170135Z	1845
1800	(M/D)	H180135W	(M/D) H180135X	(M/D) H180135Z	2010
1900	(M/D)	H190135W	(M/D) H190135X	(M/D) H190135Z	2185
2000	(M/D)	H200135W	(M/D) H200135X	(M/D) H200135Z	2370

AUGERS

SSA - H36 (Heavy Duty - Double Start Hard Soil Auger)

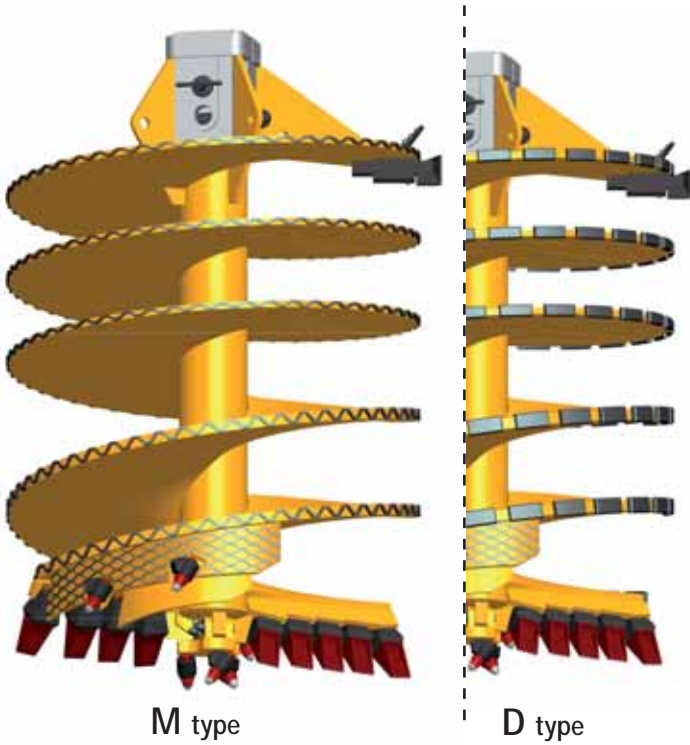

M type

D type

Heavy Duty AUGER for conglomerate soil, small size boulders (up to \varnothing 40mm), cobbles with sand and fines, cobbles with fine grained and organic soils like silty sands, sand-silt mixtures, clayey sand, sand-clay mixtures, organic and inorganic silts; cobbles with high/medium/low plasticity clays; cobbles with fat clays; cobbles with peat; cobbles with muck.

USCS soils: SM,SC, ML, CL, OL, MH, CH, OH, Pt .

Teeth: Flat pick with TC inset & round pick 30 mm shank
 Nom. length: 2350 mm (\varnothing 400 or 500 mm)
 2150 mm (\varnothing 600 or 1000 mm)
 2000 mm (from \varnothing 1100 to 1400 mm)
 1700 mm (from \varnothing 1500 to 2000 mm)

\varnothing	PART N°			Approx. Weight (kg)
	Kelly Box 130 x 130 mm	150 x 150 mm	200 x 200 mm	
400	(M/D) H040136W	(M/D) H040136X	-	575
500	(M/D) H050136W	(M/D) H050136X	-	660
600	(M/D) H060136W	(M/D) H060136X	(M/D) H060136Z	710
700	(M/D) H070136W	(M/D) H070136X	(M/D) H070136Z	825
800	(M/D) H080136W	(M/D) H080136X	(M/D) H080136Z	945
900	(M/D) H090136W	(M/D) H090136X	(M/D) H090136Z	1075
1000	(M/D) H100136W	(M/D) H100136X	(M/D) H100136Z	1240
1100	(M/D) H110136W	(M/D) H110136X	(M/D) H110136Z	1325
1200	(M/D) H120136W	(M/D) H120136X	(M/D) H120136Z	1595
1300	(M/D) H130136W	(M/D) H130136X	(M/D) H130136Z	1675
1400	(M/D) H140136W	(M/D) H140136X	(M/D) H140136Z	1885
1500	(M/D) H150136W	(M/D) H150136X	(M/D) H150136Z	1540
1600	(M/D) H160136W	(M/D) H160136X	(M/D) H160136Z	1685
1700	(M/D) H170136W	(M/D) H170136X	(M/D) H170136Z	1845
1800	(M/D) H180136W	(M/D) H180136X	(M/D) H180136Z	2010
1900	(M/D) H190136W	(M/D) H190136X	(M/D) H190136Z	2185
2000	(M/D) H200136W	(M/D) H200136X	(M/D) H200136Z	2370



SSB - 05 (Bucket)

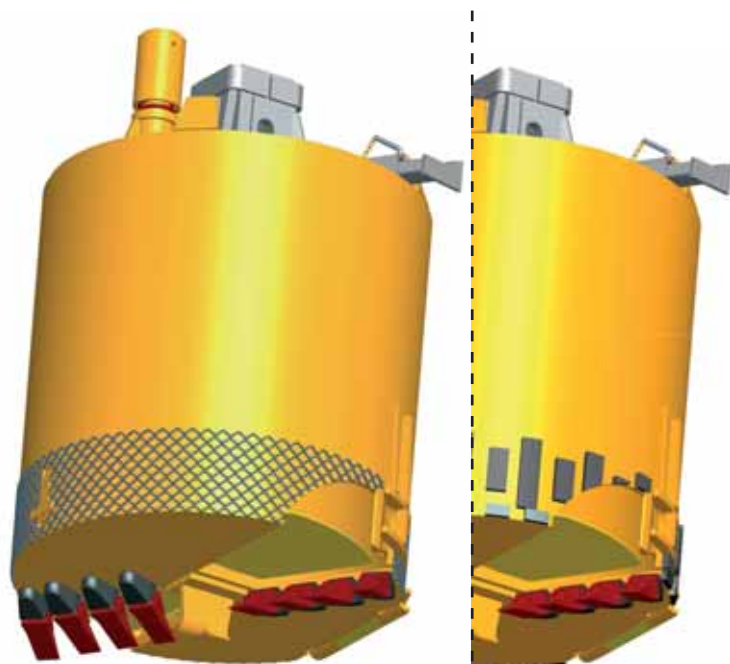

M type

D type

BUCKET for fine grained and organic soils like silty or clayey fine sands, organic/inorganic silts; high/medium/low plasticity clays; fat clays; peat; muck.

USCS soils: **ML, CL, OL, MH, CH, OH, Pt** .

Teeth: Flat ESCO Super V
Body length: 1200 mm.
Nom. length: 1600 mm.

Ø	PART N°					Approx. Weight (kg)
	Kelly Box	130 x 130 mm	150 x 150 mm	200 x 200 mm		
600	(M/D)	Z060405W	(M/D)	Z060405X	-	475
700	(M/D)	Z070405W	(M/D)	Z070405X	-	560
800	(M/D)	Z080405W	(M/D)	Z080405X	(M/D) Z080405Z	640
900	(M/D)	Z090405W	(M/D)	Z090405X	(M/D) Z090405Z	765
1000	(M/D)	Z100405W	(M/D)	Z100405X	(M/D) Z100405Z	885
1100	(M/D)	Z110405W	(M/D)	Z110405X	(M/D) Z110405Z	1020
1200	(M/D)	Z120405W	(M/D)	Z120405X	(M/D) Z120405Z	1155
1300	(M/D)	Z130405W	(M/D)	Z130405X	(M/D) Z130405Z	1290
1400	(M/D)	Z140405W	(M/D)	Z140405X	(M/D) Z140405Z	1425
1500	(M/D)	Z150405W	(M/D)	Z150405X	(M/D) Z150405Z	1560
1600	(M/D)	Z160405W	(M/D)	Z160405X	(M/D) Z160405Z	1670
1700	(M/D)	Z170405W	(M/D)	Z170405X	(M/D) Z170405Z	1775
1800	(M/D)	Z180405W	(M/D)	Z180405X	(M/D) Z180405Z	1880
1900	(M/D)	Z190405W	(M/D)	Z190405X	(M/D) Z190405Z	2000
2000	(M/D)	Z200405W	(M/D)	Z200405X	(M/D) Z200405Z	2115

SSB - H05 (Heavy Duty Bucket)

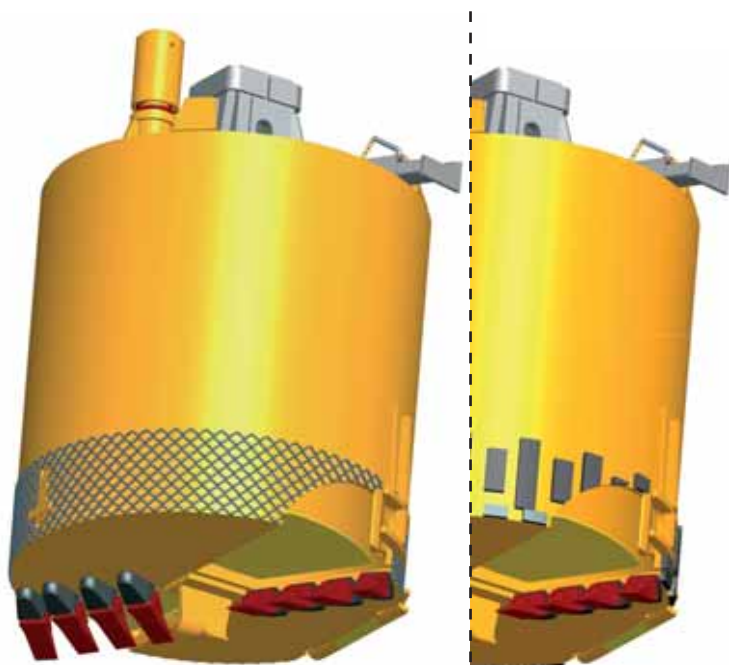

M type

D type

Heavy Duty BUCKET for sand with fines, fine grained and organic soils like silty sands, sand-silt mixtures, clayey sand, sand-clay mixtures, organic and inorganic silts; high/medium/low plasticity clays; fat clays; peat; muck.

USCS soils: **SM, SC, ML, CL, OL, MH, CH, OH, Pt**.

Teeth: Flat ESCO Super V
Body length: 1200 mm.
Nom. length: 1630 mm.

Ø	PART N°					Approx. Weight (kg)
	Kelly Box	130 x 130 mm	150 x 150 mm	200 x 200 mm		
600	(M/D)	H060405W	(M/D)	H060405X	-	575
700	(M/D)	H070405W	(M/D)	H070405X	-	680
800	(M/D)	H080405W	(M/D)	H080405X	(M/D) H080405Z	785
900	(M/D)	H090405W	(M/D)	H090405X	(M/D) H090405Z	945
1000	(M/D)	H100405W	(M/D)	H100405X	(M/D) H100405Z	1100
1100	(M/D)	H110405W	(M/D)	H110405X	(M/D) H110405Z	1270
1200	(M/D)	H120405W	(M/D)	H120405X	(M/D) H120405Z	1440
1300	(M/D)	H130405W	(M/D)	H130405X	(M/D) H130405Z	1615
1400	(M/D)	H140405W	(M/D)	H140405X	(M/D) H140405Z	1790
1500	(M/D)	H150405W	(M/D)	H150405X	(M/D) H150405Z	1960
1600	(M/D)	H160405W	(M/D)	H160405X	(M/D) H160405Z	2105
1700	(M/D)	H170405W	(M/D)	H170405X	(M/D) H170405Z	2250
1800	(M/D)	H180405W	(M/D)	H180405X	(M/D) H180405Z	2395
1900	(M/D)	H190405W	(M/D)	H190405X	(M/D) H190405Z	2510
2000	(M/D)	H200405W	(M/D)	H200405X	(M/D) H200405Z	2630

BUCKETS

SSB - G25 (Guillotine Bucket)

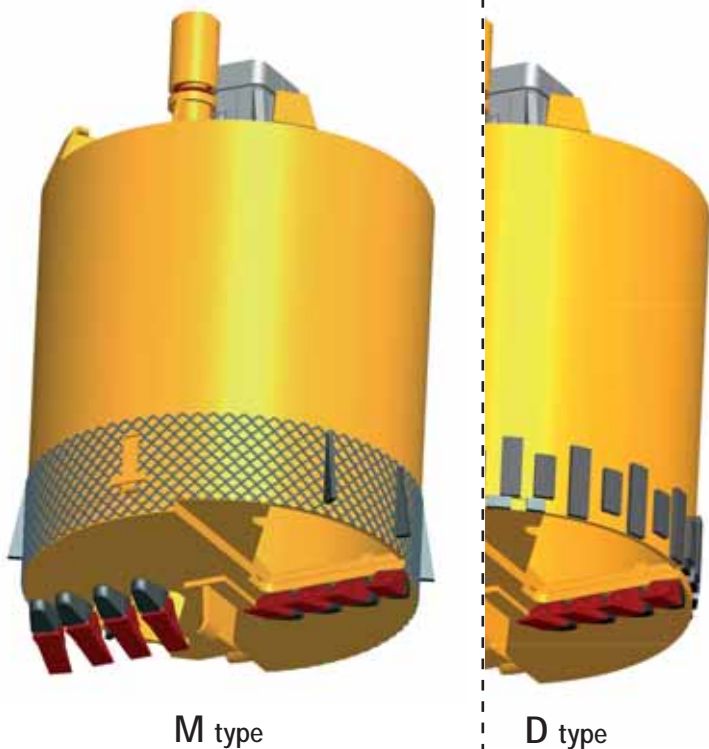

M type

D type

Guillotine BUCKET mainly for sands with 50% or more coarse fraction retained on N° 4 sieve like clean sands and sands with fines.
USCS soils: **SW, SP, SM, SC.**

Teeth: Flat ESCO Super V
Body length: 1200 mm.
Nom. length: 1650 mm.

Ø	Kelly Box	PART N°			Approx. Weight (kg)
		130 x 130 mm	150 x 150 mm	200 x 200 mm	
600	(M/D)	Z060425W	(M/D) Z060425X	(M/D) Z060425Z	505
700	(M/D)	Z070425W	(M/D) Z070425X	(M/D) Z070425Z	610
800	(M/D)	Z080425W	(M/D) Z080425X	(M/D) Z080425Z	715
900	(M/D)	Z090425W	(M/D) Z090425X	(M/D) Z090425Z	850
1000	(M/D)	Z100425W	(M/D) Z100425X	(M/D) Z100425Z	990
1100	(M/D)	Z110425W	(M/D) Z110425X	(M/D) Z110425Z	1140
1200	(M/D)	Z120425W	(M/D) Z120425X	(M/D) Z120425Z	1290
1300	(M/D)	Z130425W	(M/D) Z130425X	(M/D) Z130425Z	1445
1400	(M/D)	Z140425W	(M/D) Z140425X	(M/D) Z140425Z	1600
1500	(M/D)	Z150425W	(M/D) Z150425X	(M/D) Z150425Z	1755
1600	(M/D)	Z160425W	(M/D) Z160425X	(M/D) Z160425Z	1910
1700	(M/D)	Z170425W	(M/D) Z170425X	(M/D) Z170425Z	2060
1800	(M/D)	Z180425W	(M/D) Z180425X	(M/D) Z180425Z	2215
1900	(M/D)	Z190425W	(M/D) Z190425X	(M/D) Z190425Z	2370
2000	(M/D)	Z200425W	(M/D) Z200425X	(M/D) Z200425Z	2525

SSB - GH25 (Heavy Duty Guillotine Bucket)

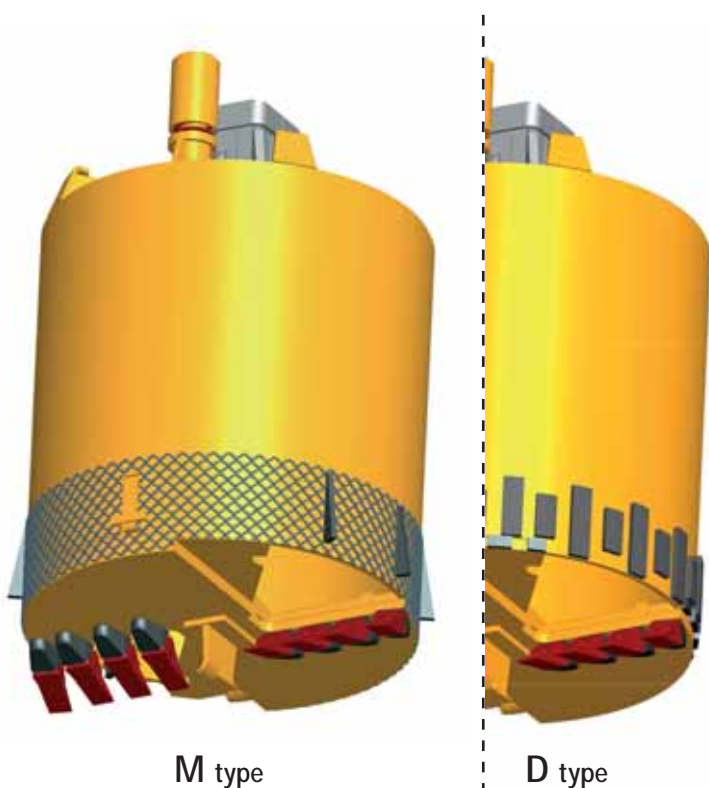

M type

D type

Heavy Duty Guillotine BUCKET for coarse grained soils like clean gravels, gravel with fines, clean sands and sands with fines.

USCS soils: **GW, GP, GM, GC SW, SP, SM, SC.**

Teeth: Flat ESCO Super V
Body length: 1200 mm.
Nom. length: 1700 mm.

Ø	Kelly Box	PART N°			Approx. Weight (kg)
		130 x 130 mm	150 x 150 mm	200 x 200 mm	
600	(M/D)	H060425W	(M/D) H060425X	(M/D) H060425Z	685
700	(M/D)	H070425W	(M/D) H070425X	(M/D) H070425Z	790
800	(M/D)	H080425W	(M/D) H080425X	(M/D) H080425Z	895
900	(M/D)	H090425W	(M/D) H090425X	(M/D) H090425Z	1070
1000	(M/D)	H100425W	(M/D) H100425X	(M/D) H100425Z	1250
1100	(M/D)	H110425W	(M/D) H110425X	(M/D) H110425Z	1445
1200	(M/D)	H120425W	(M/D) H120425X	(M/D) H120425Z	1645
1300	(M/D)	H130425W	(M/D) H130425X	(M/D) H130425Z	1850
1400	(M/D)	H140425W	(M/D) H140425X	(M/D) H140425Z	2060
1500	(M/D)	H150425W	(M/D) H150425X	(M/D) H150425Z	2265
1600	(M/D)	H160425W	(M/D) H160425X	(M/D) H160425Z	2475
1700	(M/D)	H170425W	(M/D) H170425X	(M/D) H170425Z	2680
1800	(M/D)	H180425W	(M/D) H180425X	(M/D) H180425Z	2885
1900	(M/D)	H190425W	(M/D) H190425X	(M/D) H190425Z	3095
2000	(M/D)	H200425W	(M/D) H200425X	(M/D) H200425Z	3300

SSB - LW30 (Compact Guillotine Bucket)

Compact BUCKET for clean sands, sands with fines, fine grained and organic soils like well graded sand, fine to coarse sand, silty sands, clayey sands, silty or clayey fine sands, organic/inorganic silts; high/medium/low plasticity clays; fat clays; peat; muck.
USCS soils: **SW, SP, SM, SC, ML, CL, OL, MH, CH, OH, Pt** .

Teeth: Flat ESCO Super V
Body length: 700 mm.
Nom. length: 1050 mm.

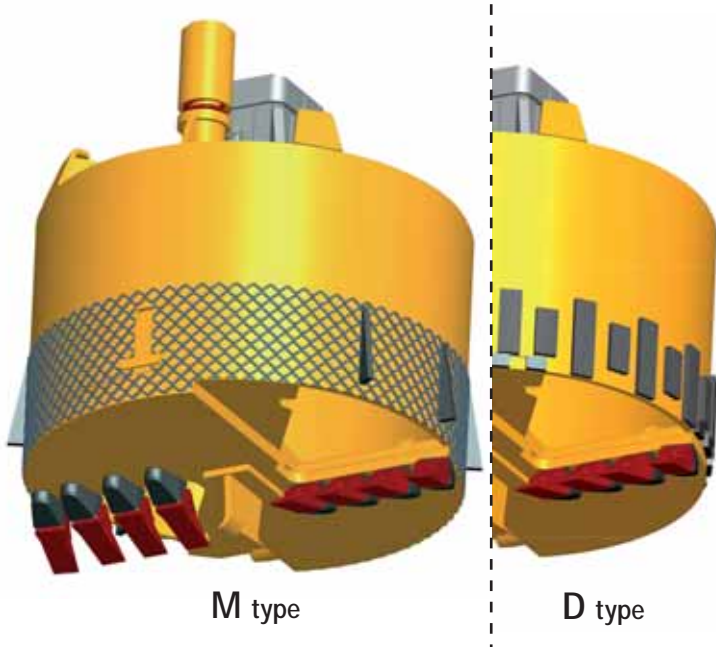

Ø	PART N°			Approx. Weight (kg)
	Kelly Box 130 x 130 mm	150 x 150 mm	200 x 200 mm	
600	(M/D) Z060430W	(M/D) Z060430X	(M/D) Z060430Z	350
700	(M/D) Z070430W	(M/D) Z070430X	(M/D) Z070430Z	455
800	(M/D) Z080430W	(M/D) Z080430X	(M/D) Z080430Z	575
900	(M/D) Z090430W	(M/D) Z090430X	(M/D) Z090430Z	690
1000	(M/D) Z100430W	(M/D) Z100430X	(M/D) Z100430Z	810
1100	(M/D) Z110430W	(M/D) Z110430X	(M/D) Z110430Z	925
1200	(M/D) Z120430W	(M/D) Z120430X	(M/D) Z120430Z	1045
1300	(M/D) Z130430W	(M/D) Z130430X	(M/D) Z130430Z	1175
1400	(M/D) Z140430W	(M/D) Z140430X	(M/D) Z140430Z	1310
1500	(M/D) Z150430W	(M/D) Z150430X	(M/D) Z150430Z	1445
1600	(M/D) Z160430W	(M/D) Z160430X	(M/D) Z160430Z	1575
1700	(M/D) Z170430W	(M/D) Z170430X	(M/D) Z170430Z	1710
1800	(M/D) Z180430W	(M/D) Z180430X	(M/D) Z180430Z	1845
1900	(M/D) Z190430W	(M/D) Z190430X	(M/D) Z190430Z	1980
2000	(M/D) Z200430W	(M/D) Z200430X	(M/D) Z200430Z	2115

SSB - CN60 (Heavy Duty Conical Bottom Bucket)

Heavy Duty Conical bottom BUCKET for sand with fines, fine grained and organic soils like silty sands, sand-silt mixtures, clayey sand, sand-clay mixtures, organic and inorganic silts; high/medium/low plasticity clays; fat clays; peat; muck.
USCS soils: **SM, SC, ML, CL, OL, MH, CH, OH, Pt**.

Teeth: Flat ESCO Super V
Body length: 1200 mm.
Nom. length: 1600 mm.

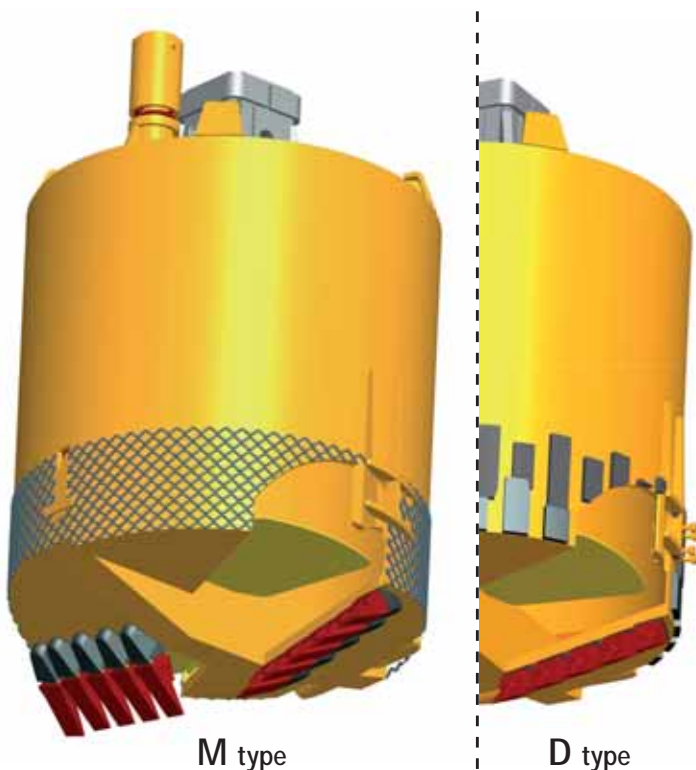

Ø	PART N°			Approx. Weight (kg)
	Kelly Box 130 x 130 mm	150 x 150 mm	200 x 200 mm	
600	(M/D) H060460W	(M/D) H060460X	-	550
700	(M/D) H070460W	(M/D) H070460X	-	730
800	(M/D) H080460W	(M/D) H080460X	(M/D) H080460Z	930
900	(M/D) H090460W	(M/D) H090460X	(M/D) H090460Z	1110
1000	(M/D) H100460W	(M/D) H100460X	(M/D) H100460Z	1295
1100	(M/D) H110460W	(M/D) H110460X	(M/D) H110460Z	1480
1200	(M/D) H120460W	(M/D) H120460X	(M/D) H120460Z	1665
1300	(M/D) H130460W	(M/D) H130460X	(M/D) H130460Z	1875
1400	(M/D) H140460W	(M/D) H140460X	(M/D) H140460Z	2090
1500	(M/D) H150460W	(M/D) H150460X	(M/D) H150460Z	2305
1600	(M/D) H160460W	(M/D) H160460X	(M/D) H160460Z	2505
1700	(M/D) H170460W	(M/D) H170460X	(M/D) H170460Z	2700
1800	(M/D) H180460W	(M/D) H180460X	(M/D) H180460Z	2900
1900	(M/D) H190460W	(M/D) H190460X	(M/D) H190460Z	3100
2000	(M/D) H200460W	(M/D) H200460X	(M/D) H200460Z	3295

BUCKETS

SSB - CL05 (Cleaning Bucket)

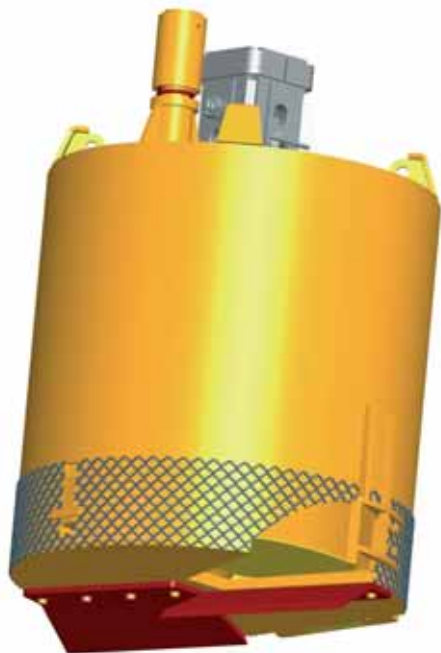

M type

Heavy Duty Cleaning BUCKET for fine grained and organic soils like silty or clayey fine sands, organic/inorganic silts; high/medium/low plasticity clays; fat clays; peat; muck.
USCS soils: **ML, CL, OL, MH, CH, OH, Pt.**

Teeth: *Hardox Blade.*
Body length: *1200 mm.*

Ø	Kelly Box	PART N°			Approx. Weight (kg)
		130 x 130 mm	150 x 150 mm	200 x 200 mm	
600	MC060405W	MC060405X	-	475	
700	MC070405W	MC070405X	-	560	
800	MC080405W	MC080405X	MC080405Z	640	
900	MC090405W	MC090405X	MC090405Z	765	
1000	MC100405W	MC100405X	MC100405Z	885	
1100	MC110405W	MC110405X	MC110405Z	120	
1200	MC120405W	MC120405X	MC120405Z	1155	
1300	MC130405W	MC130405X	MC130405Z	1290	
1400	MC140405W	MC140405X	MC140405Z	1425	
1500	MC150405W	MC150405X	MC150405Z	1560	
1600	MC160405W	MC160405X	MC160405Z	1670	
1700	MC170405W	MC170405X	MC170405Z	1775	
1800	MC180405W	MC180405X	MC180405Z	1880	
1900	MC190405W	MC190405X	MC190405Z	2000	
2000	MC200405W	MC200405X	MC200405Z	2115	

SSB - GCL25 (Guillotine Cleaning Bucket)

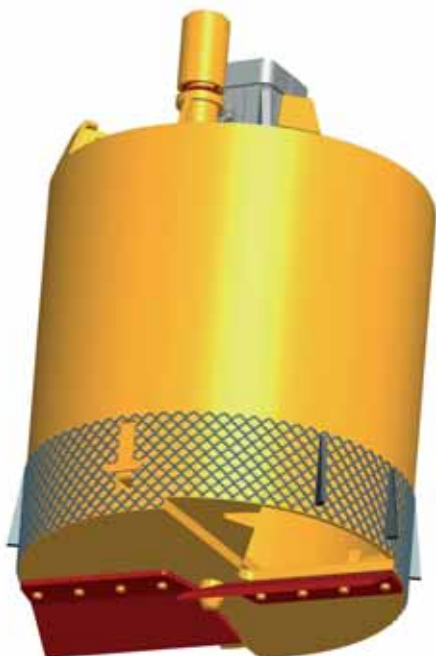

M type

Heavy Duty Guillotine Cleaning BUCKET for coarse grained soils like clean gravels, gravel with fines, clean sands and sands with fines.
USCS soils: **GW, GP, GM, GC SW, SP, SM, SC.**

Teeth: *Hardox Blade.*
Body length: *1200 mm.*

Ø	Kelly Box	PART N°			Approx. Weight (kg)
		130 x 130 mm	150 x 150 mm	200 x 200 mm	
600	MC060425W	MC060425X	MC060425Z	550	
700	MC070425W	MC070425X	MC070425Z	635	
800	MC080425W	MC080425X	MC080425Z	715	
900	MC090425W	MC090425X	MC090425Z	850	
1000	MC100425W	MC100425X	MC100425Z	990	
1100	MC110425W	MC110425X	MC110425Z	1140	
1200	MC120425W	MC120425X	MC120425Z	1290	
1300	MC130425W	MC130425X	MC130425Z	1445	
1400	MC140425W	MC140425X	MC140425Z	1600	
1500	MC150425W	MC150425X	MC150425Z	1755	
1600	MC160425W	MC160425X	MC160425Z	1910	
1700	MC170425W	MC170425X	MC170425Z	2060	
1800	MC180425W	MC180425X	MC180425Z	2215	
1900	MC190425W	MC190425X	MC190425Z	2370	
2000	MC200425W	MC200425X	MC200425Z	2525	

SSB - SP00 (Hardpan Bucket)

BUCKET for fine grained and organic soils like silty or clayey, high/plasticity clays; fat clays; peat; muck.
Normally used on small diameters.

USCS soils: **MH, CH, OH, Pt.**

Teeth: Flat ESCO Super V
Body length: 1200 mm.

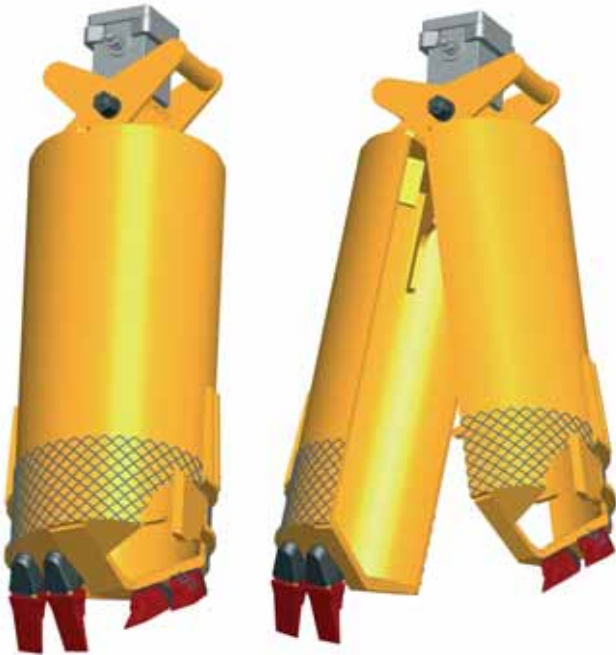

M type

PART N°				
Ø	Kelly Box 130 x 130 mm	150 x 150 mm	200 x 200 mm	Approx. Weight (kg)
500	MH050400W	MH050400X	-	600
600	MH060400W	MH060400X	-	750
700	MH070400W	MH070400X	-	900
800	MH080400W	MH080400X	MH080400Z	1050

SSB - H01 (Centrifugal Bucket)

Heavy Duty centrifugal BUCKET for fine grained and organic soils like silty or clay, high plasticity clays; fat clays; peat; muck.

USCS soils: **MH, CH, OH, Pt.**

Diameter (Ø): 500 mm – 800 mm.
Teeth: Flat ESCO Super V
Body length: 1200 mm.

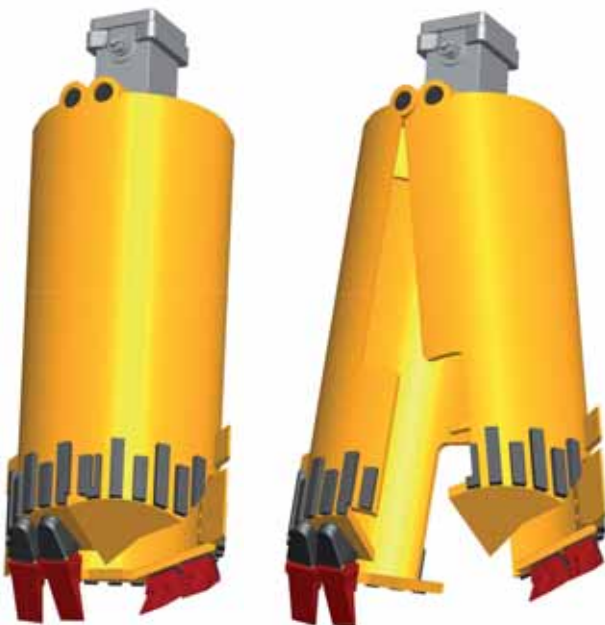

M/D type

PART N°				
Ø	Kelly Box 130 x 130 mm	150 x 150 mm	200 x 200 mm	Approx. Weight (kg)
500	(M/D) H050401W	(M/D) H050401X	-	600
600	(M/D) H060401W	(M/D) H060401X	-	750
700	(M/D) H070401W	(M/D) H070401X	-	900
800	(M/D) H080401W	(M/D) H080401X	(M/D) H080401Z	1050

SSB - BB10 (Belling Bucket)

Mx. Bell Diam: 2 Ø (1200 mm - 3000 mm)
Teeth: Flat ESCO Super V

Ø	Kelly Box	PART N°			Approx. Weight (kg)
		130 x 130 mm	150 x 150 mm	200 x 200 mm	
600	MH060410W	MH060410X	MH060410Z	690	
700	MH070410W	MH070410X	MH070410Z	1000	
800	MH080410W	MH080410X	MH080410Z	1400	
900	MH090410W	MH090410X	MH090410Z	1600	
1000	MH100410W	MH100410X	MH100410Z	2300	
1100	MH110410W	MH110410X	MH110410Z	2700	
1200	MH120410W	MH120410X	MH120410Z	3150	
1300	MH130410W	MH130410X	MH130410Z	3600	
1400	MH140410W	MH140410X	MH140410Z	4000	
1500	MH150410W	MH150410X	MH150410Z	4500	

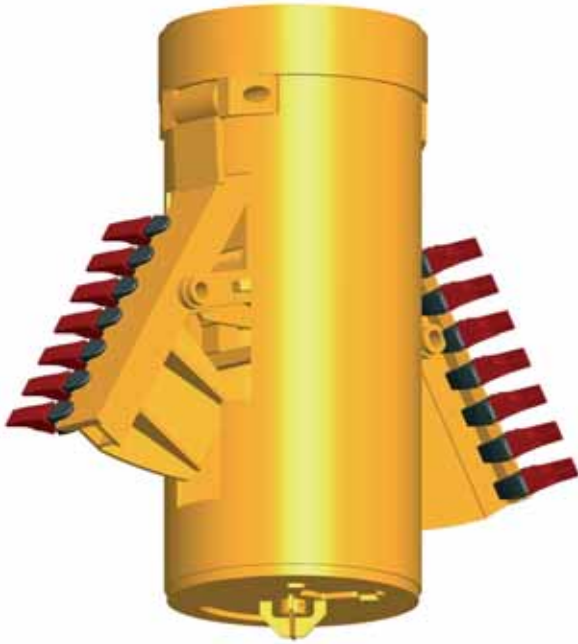

M type



ROCK DRILLING TOOLS

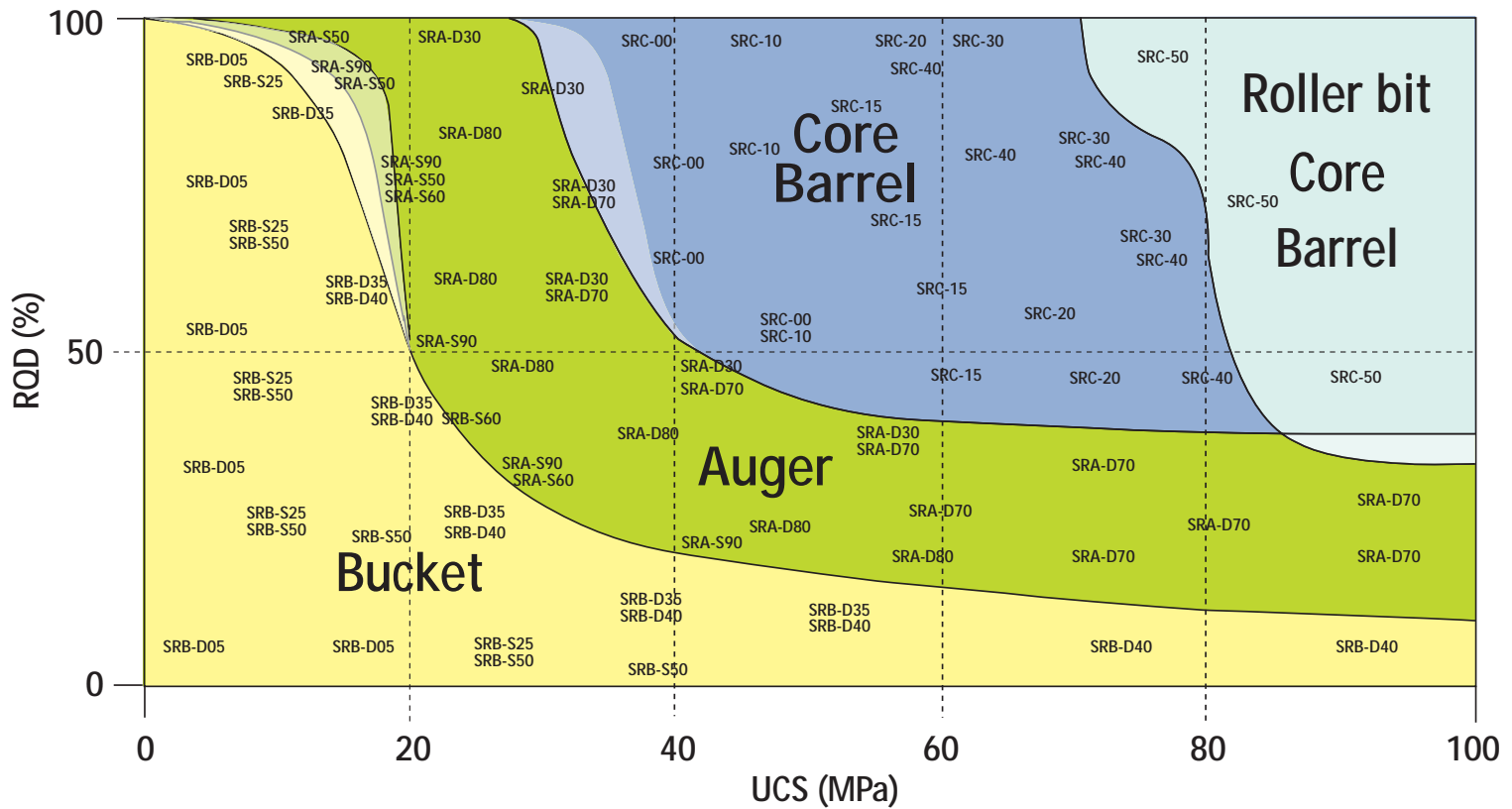

Rock main properties affecting cutting performance are:

- Uniaxial compressive strength [MPa] and tensile strength [MPa]
- Abrasivity or quartz content
- Structure of the rock (i.e. number and distance and direction of fractures)

Soilmec Drilling Tools are capable to cut rock with a hardness up to 100 MPa strength.
Under certain circumstances (e.g. highly fractured material) even harder material can be cut.



SRA - D30 (Heavy Duty - Double Start Rock Auger)

Heavy Duty double start SRA-D30 auger built-in with 25 mm round shank pick. Generally used for cutting medium-soft rock formations, low fractured medium-hard rock formation and decompressed rock formations.

Teeth: 25 mm Shank.
 Nom. length: 1240 mm (Ø 400 or 500 mm).
 1440 mm (from Ø 600 to 1000 mm and from 1500 to 2000 mm)
 1640 mm (from Ø 1100 to 1400 mm)

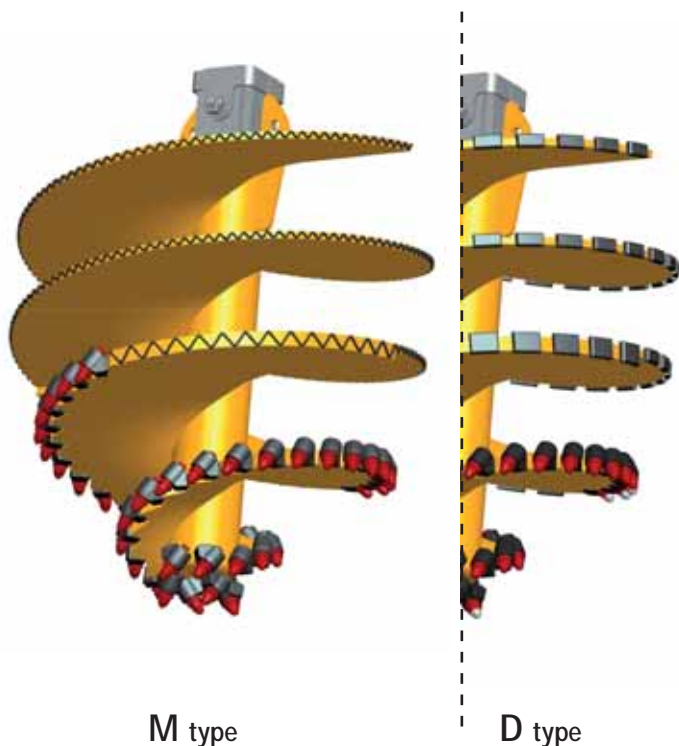

Ø	PART N°			Approx. Weight (kg)
	Kelly Box 130 x 130 mm	150 x 150 mm	200 x 200 mm	
400	(M/D) Q040130W	(M/D) Q040130X	-	255
500	(M/D) Q050130W	(M/D) Q050130X	-	285
600	(M/D) Q060130W	(M/D) Q060130X	(M/D) Q060130Z	385
700	(M/D) Q070130W	(M/D) Q070130X	(M/D) Q070130Z	435
800	(M/D) Q080130W	(M/D) Q080130X	(M/D) Q080130Z	570
900	(M/D) Q090130W	(M/D) Q090130X	(M/D) Q090130Z	660
1000	(M/D) Q100130W	(M/D) Q100130X	(M/D) Q100130Z	755
1100	(M/D) Q110130W	(M/D) Q110130X	(M/D) Q110130Z	915
1200	(M/D) Q120130W	(M/D) Q120130X	(M/D) Q120130Z	1035
1300	(M/D) Q130130W	(M/D) Q130130X	(M/D) Q130130Z	1165
1400	(M/D) Q140130W	(M/D) Q140130X	(M/D) Q140130Z	1320
1500	(M/D) Q150130W	(M/D) Q150130X	(M/D) Q150130Z	1170
1600	(M/D) Q160130W	(M/D) Q160130X	(M/D) Q160130Z	1310
1700	(M/D) Q170130W	(M/D) Q170130X	(M/D) Q170130Z	1430
1800	(M/D) Q180130W	(M/D) Q180130X	(M/D) Q180130Z	1575
1900	(M/D) Q190130W	(M/D) Q190130X	(M/D) Q190130Z	1725
2000	(M/D) Q200130W	(M/D) Q200130X	(M/D) Q200130Z	1900

SRA - S50 (Heavy Duty - Single Start Rock Auger)

Heavy Duty single start augers built-in with 25 mm round shank pick. Generally used for cutting soft rock formation, low fractured medium-soft rock formation and decompressed rock formations.

Teeth: 25 mm Shank.
 Nom. length: 2300 mm (Ø 400 to 700 mm).
 2000 mm (from Ø 800 to 2000 mm)

M type

Ø	PART N°				Weight (kg)
	Kelly Box 130 x 130 mm	150 x 150 mm	200 x 200 mm		
400	(M/D) Q040150W	(M/D) Q040150X	(M/D) -	-	380
500	(M/D) Q050150W	(M/D) Q050150X	(M/D) -	-	510
600	(M/D) Q060150W	(M/D) Q060150X	(M/D) Q060150Z	-	564
700	(M/D) Q070150W	(M/D) Q070150X	(M/D) Q070150Z	-	680
800	(M/D) Q080150W	(M/D) Q080150X	(M/D) Q080150Z	-	750
900	(M/D) Q090150W	(M/D) Q090150X	(M/D) Q090150Z	-	893
1000	(M/D) Q100150W	(M/D) Q100150X	(M/D) Q100150Z	-	1033
1100	(M/D) Q110150W	(M/D) Q110150X	(M/D) Q110150Z	-	1192
1200	(M/D) Q120150W	(M/D) Q120150X	(M/D) Q120150Z	-	1349
1300	(M/D) Q130150W	(M/D) Q130150X	(M/D) Q130150Z	-	1561
1400	(M/D) Q140150W	(M/D) Q140150X	(M/D) Q140150Z	-	1765
1500	(M/D) Q150150W	(M/D) Q150150X	(M/D) Q150150Z	-	2058
1600	(M/D) Q160150W	(M/D) Q160150X	(M/D) Q160150Z	-	2310
1700	(M/D) Q170150W	(M/D) Q170150X	(M/D) Q170150Z	-	2560
1800	(M/D) Q180150W	(M/D) Q180150X	(M/D) Q180150Z	-	2541
1900	(M/D) Q190150W	(M/D) Q190150X	(M/D) Q190150Z	-	2783
2000	(M/D) Q200150W	(M/D) Q200150X	(M/D) Q200150Z	-	3017

D type



SRA - S60 (Heavy Duty - Single Start Rock Auger)

Heavy Duty single start augers built-in with 30 mm round shank pick. Generally used for cutting soft rock formation, medium-soft fractured rock formation and decompressed rock formations.

Teeth: 30 mm Shank.
 Nom. length: 2300 mm (Ø 400 to 700 mm).
 2000 mm (from Ø 800 to 2000 mm)

Ø	PART N°				Weight (kg)
	Kelly Box 130 x 130 mm	150 x 150 mm	200 x 200 mm		
400	(M/D) Q040160W	(M/D) Q040160X	(M/D) -	-	380
500	(M/D) Q050160W	(M/D) Q050160X	(M/D) -	-	510
600	(M/D) Q060160W	(M/D) Q060160X	(M/D) Q060160Z	-	564
700	(M/D) Q070160W	(M/D) Q070160X	(M/D) Q070160Z	-	680
800	(M/D) Q080160W	(M/D) Q080160X	(M/D) Q080160Z	-	750
900	(M/D) Q090160W	(M/D) Q090160X	(M/D) Q090160Z	-	893
1000	(M/D) Q100160W	(M/D) Q100160X	(M/D) Q100160Z	-	1033
1100	(M/D) Q110160W	(M/D) Q110160X	(M/D) Q110160Z	-	1192
1200	(M/D) Q120160W	(M/D) Q120160X	(M/D) Q120160Z	-	1349
1300	(M/D) Q130160W	(M/D) Q130160X	(M/D) Q130160Z	-	1561
1400	(M/D) Q140160W	(M/D) Q140160X	(M/D) Q140160Z	-	1765
1500	(M/D) Q150160W	(M/D) Q150160X	(M/D) Q150160Z	-	2058
1600	(M/D) Q160160W	(M/D) Q160160X	(M/D) Q160160Z	-	2310
1700	(M/D) Q170160W	(M/D) Q170160X	(M/D) Q170160Z	-	2560
1800	(M/D) Q180160W	(M/D) Q180160X	(M/D) Q180160Z	-	2541
1900	(M/D) Q190160W	(M/D) Q190160X	(M/D) Q190160Z	-	2783
2000	(M/D) Q200160W	(M/D) Q200160X	(M/D) Q200160Z	-	3017

AUGERS

SRA - D70 (Heavy Duty - Double Start Rock Auger)

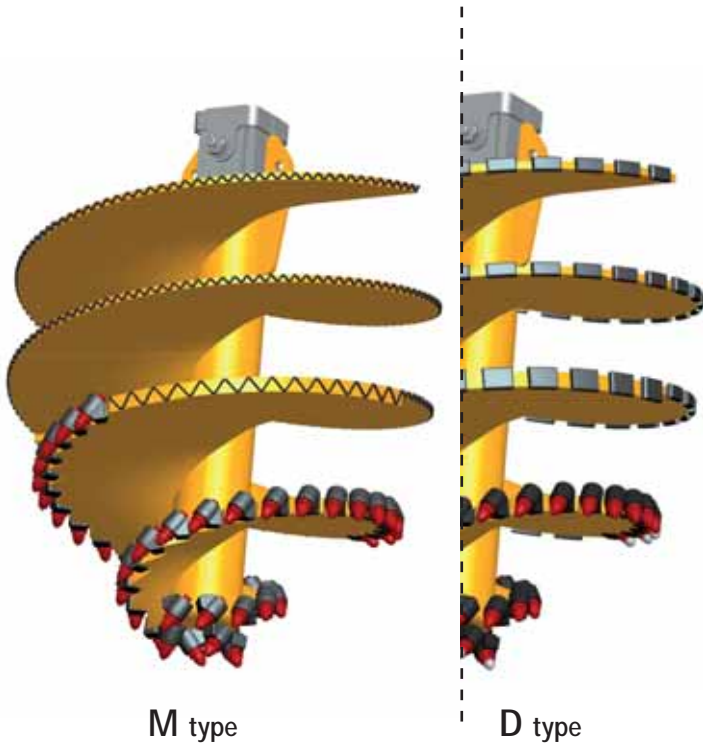

Heavy Duty double start SRA-D70 auger built-in with 30 mm round shank pick. Generally used for cutting medium-soft rock formations, high fractured medium-hard rock formation and decompressed rock formations.

Teeth: 30 mm Shank.
Nom. length: 1240 mm (Ø 400 or 500 mm).
1440 mm (from Ø 600 to 1000 mm and from 1500 to 2000 mm).
1640 mm (from Ø 1100 to 1400 mm).

Ø	PART N°			Approx. Weight (kg)
	Kelly Box 130 x 130 mm	150 x 150 mm	200 x 200 mm	
400	(M/D) Q040170W	(M/D) Q040170X	-	455
500	(M/D) Q050170W	(M/D) Q050170X	-	485
600	(M/D) Q060170W	(M/D) Q060170X	(M/D) Q060170Z	585
700	(M/D) Q070170W	(M/D) Q070170X	(M/D) Q070170Z	635
800	(M/D) Q080170W	(M/D) Q080170X	(M/D) Q080170Z	770
900	(M/D) Q090170W	(M/D) Q090170X	(M/D) Q090170Z	860
1000	(M/D) Q100170W	(M/D) Q100170X	(M/D) Q100170Z	955
1100	(M/D) Q110170W	(M/D) Q110170X	(M/D) Q110170Z	1115
1200	(M/D) Q120170W	(M/D) Q120170X	(M/D) Q120170Z	1235
1300	(M/D) Q130170W	(M/D) Q130170X	(M/D) Q130170Z	1565
1400	(M/D) Q140170W	(M/D) Q140170X	(M/D) Q140170Z	1520
1500	(M/D) Q150170W	(M/D) Q150170X	(M/D) Q150170Z	1370
1600	(M/D) Q160170W	(M/D) Q160170X	(M/D) Q160170Z	1510
1700	(M/D) Q170170W	(M/D) Q170170X	(M/D) Q170170Z	1630
1800	(M/D) Q180170W	(M/D) Q180170X	(M/D) Q180170Z	1775
1900	(M/D) Q190170W	(M/D) Q190170X	(M/D) Q190170Z	1925
2000	(M/D) Q200170W	(M/D) Q200170X	(M/D) Q200170Z	2100

SRA - S90 (Heavy Duty - Guillottine Single Start Rock Auger)

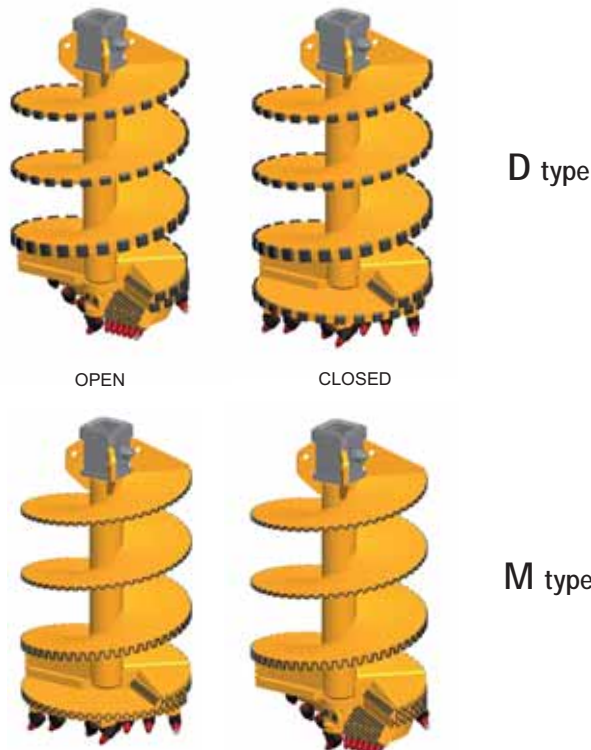

Single start Heavy Duty rock AUGER with revolving bottom. Mainly used for well cemented conglomerates soils, agglomerates, medium-soft fractured rock formation and decompressed rocks. Revolving bottom solution increase auger capacity to extract drilled material.

Teeth: 30 mm Shank.
Nom. length: 2300 mm (Ø 400 to 700 mm).
2000 mm (from Ø 800 to 2000 mm)

Ø	PART N°			Approx. Weight (kg)
	Kelly Box 130 x 130 mm	150 x 150 mm	200 x 200 mm	
400	(M/D) Q040190W	(M/D) Q040190X	-	580
500	(M/D) Q050190W	(M/D) Q050190X	-	710
600	(M/D) Q060190W	(M/D) Q060190X	(M/D) Q060190Z	764
700	(M/D) Q070190W	(M/D) Q070190X	(M/D) Q070190Z	880
800	(M/D) Q080190W	(M/D) Q080190X	(M/D) Q080190Z	950
900	(M/D) Q090190W	(M/D) Q090190X	(M/D) Q090190Z	1093
1000	(M/D) Q100190W	(M/D) Q100190X	(M/D) Q100190Z	1233
1100	(M/D) Q110190W	(M/D) Q110190X	(M/D) Q110190Z	1392
1200	(M/D) Q120190W	(M/D) Q120190X	(M/D) Q120190Z	1549
1300	(M/D) Q130190W	(M/D) Q130190X	(M/D) Q130190Z	1761
1400	(M/D) Q140190W	(M/D) Q140190X	(M/D) Q140190Z	1965
1500	(M/D) Q150190W	(M/D) Q150190X	(M/D) Q150190Z	2258
1600	(M/D) Q160190W	(M/D) Q160190X	(M/D) Q160190Z	2510
1700	(M/D) Q170190W	(M/D) Q170190X	(M/D) Q170190Z	2760
1800	(M/D) Q180190W	(M/D) Q180190X	(M/D) Q180190Z	2741
1900	(M/D) Q190190W	(M/D) Q190190X	(M/D) Q190190Z	2983
2000	(M/D) Q200190W	(M/D) Q200190X	(M/D) Q200190Z	3217

AUGERS

SRA - D80 (Heavy Duty - Double Start Rock Auger)

Heavy Duty double start SRA-D80 auger built-in with 30 mm round shank picks. Generally used for cutting fractured medium-hard rock formation combined with fines and coarse soil formation.

Teeth: 30 mm Shank.
Nom. length: 2300 mm (Ø 500 to 700 mm),
2000 mm (from Ø 800 to 2000).

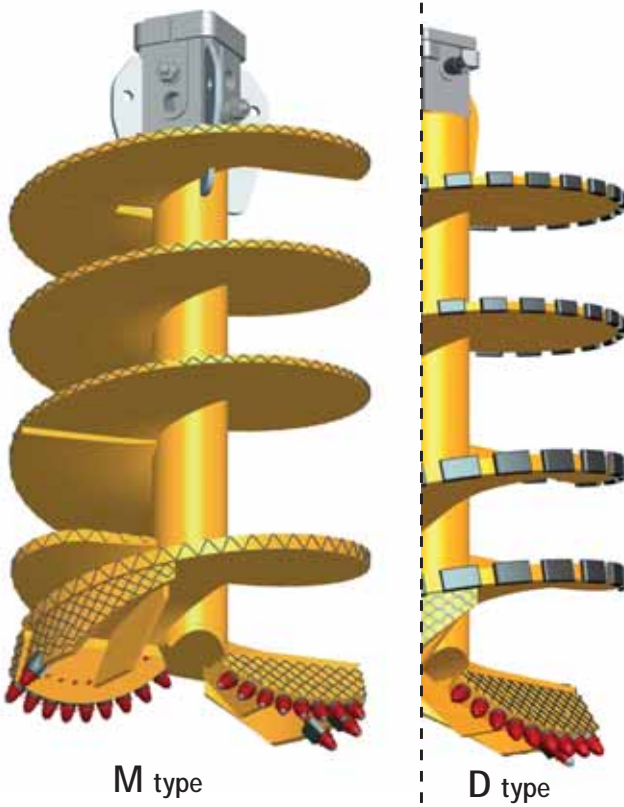

M type

D type

Ø	PART N°			Approx. Weight (kg)
	Kelly Box 130 x 130 mm	150 x 150 mm	200 x 200 mm	
500	(M/D) Q050180W	(M/D) Q050180X	-	785
600	(M/D) Q060180W	(M/D) Q060180X	(M/D) Q060180Z	885
700	(M/D) Q070180W	(M/D) Q070180X	(M/D) Q070180Z	935
800	(M/D) Q080180W	(M/D) Q080180X	(M/D) Q080180Z	1070
900	(M/D) Q090180W	(M/D) Q090180X	(M/D) Q090180Z	1160
1000	(M/D) Q100180W	(M/D) Q100180X	(M/D) Q100180Z	1255
1100	(M/D) Q110180W	(M/D) Q110180X	(M/D) Q110180Z	1415
1200	(M/D) Q120180W	(M/D) Q120180X	(M/D) Q120180Z	1535
1300	(M/D) Q130180W	(M/D) Q130180X	(M/D) Q130180Z	1665
1400	(M/D) Q140180W	(M/D) Q140180X	(M/D) Q140180Z	1820
1500	(M/D) Q150180W	(M/D) Q150180X	(M/D) Q150180Z	1670
1600	(M/D) Q160180W	(M/D) Q160180X	(M/D) Q160180Z	1810
1700	(M/D) Q170180W	(M/D) Q170180X	(M/D) Q170180Z	1930
1800	(M/D) Q180180W	(M/D) Q180180X	(M/D) Q180180Z	2075
1900	(M/D) Q190180W	(M/D) Q190180X	(M/D) Q190180Z	2225
2000	(M/D) Q200180W	(M/D) Q200180X	(M/D) Q200180Z	2400



SRB - D05 (Heavy Duty - Double Blade Rock Bucket)

Double blade Heavy Duty SRB-D05 Bucket. Used for cutting soft to medium-hard fractured rock formation combined with low fines and coarse soil; decompressed rock formations.

Teeth: 25 mm Shank.
Body length: 1200 mm.
Nom. length: 1800 mm.

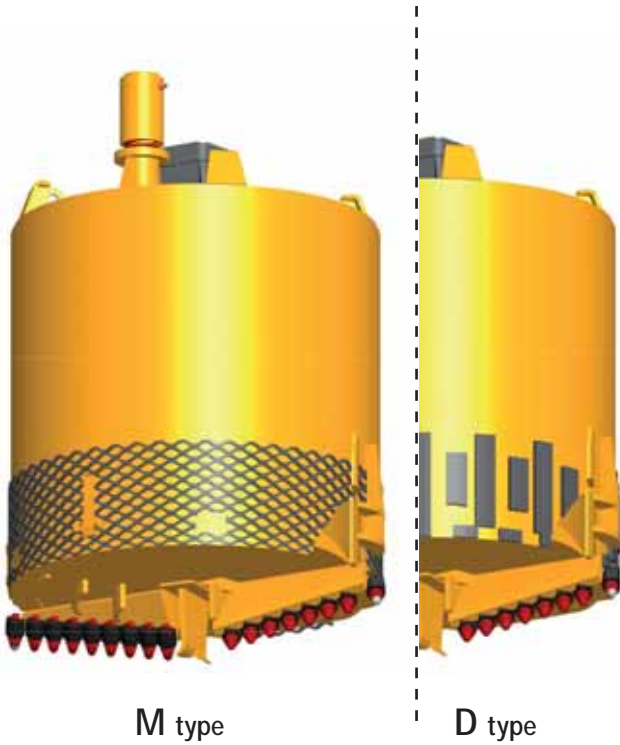

M type

D type

Ø	PART N°			Approx. Weight (kg)
	Kelly Box 130 x 130 mm	150 x 150 mm	200 x 200 mm	
600	(M/D) Q060405W	(M/D) Q060405X	-	410
700	(M/D) Q070405W	(M/D) Q070405X	-	565
800	(M/D) Q080405W	(M/D) Q080405X	(M/D) Q080405Z	740
900	(M/D) Q090405W	(M/D) Q090405X	(M/D) Q090405Z	910
1000	(M/D) Q100405W	(M/D) Q100405X	(M/D) Q100405Z	1085
1100	(M/D) Q110405W	(M/D) Q110405X	(M/D) Q110405Z	1270
1200	(M/D) Q120405W	(M/D) Q120405X	(M/D) Q120405Z	1450
1300	(M/D) Q130405W	(M/D) Q130405X	(M/D) Q130405Z	1665
1400	(M/D) Q140405W	(M/D) Q140405X	(M/D) Q140405Z	1885
1500	(M/D) Q150405W	(M/D) Q150405X	(M/D) Q150405Z	2090
1600	(M/D) Q160405W	(M/D) Q160405X	(M/D) Q160405Z	2290
1700	(M/D) Q170405W	(M/D) Q170405X	(M/D) Q170405Z	2485
1800	(M/D) Q180405W	(M/D) Q180405X	(M/D) Q180405Z	2680
1900	(M/D) Q190405W	(M/D) Q190405X	(M/D) Q190405Z	2875
2000	(M/D) Q200405W	(M/D) Q200405X	(M/D) Q200405Z	3075



M type

SRB - S25 (Heavy Duty - Guillotine Single Blade Rock Bucket)

Single blade Heavy Duty SRB-S25 Bucket. Used for cutting soft and medium-soft fractured rock formations; decompressed rock formations.

Teeth: 25 mm Shank
Body length: 1200 mm
Nom. length: 1800 mm

Ø	PART N°			Weight (kg)
	Kelly Box 130 x 130 mm	150 x 150 mm	200 x 200 mm	
600	(M/D) Q060425W	(M/D) Q060425X	(M/D) -	565
700	(M/D) Q070425W	(M/D) Q070425X	(M/D) -	750
800	(M/D) Q080425W	(M/D) Q080425X	(M/D) Q080425Z	930
900	(M/D) Q090425W	(M/D) Q090425X	(M/D) Q090425Z	1110
1000	(M/D) Q100425W	(M/D) Q100425X	(M/D) Q100425Z	1295
1100	(M/D) Q110425W	(M/D) Q110425X	(M/D) Q110425Z	1480
1200	(M/D) Q120425W	(M/D) Q120425X	(M/D) Q120425Z	1665
1300	(M/D) Q130425W	(M/D) Q130425X	(M/D) Q130425Z	1875
1400	(M/D) Q140425W	(M/D) Q140425X	(M/D) Q140425Z	2090
1500	(M/D) Q150425W	(M/D) Q150425X	(M/D) Q150425Z	2305
1600	(M/D) Q160425W	(M/D) Q160425X	(M/D) Q160425Z	2505
1700	(M/D) Q170425W	(M/D) Q170425X	(M/D) Q170425Z	2700
1800	(M/D) Q180425W	(M/D) Q180425X	(M/D) Q180425Z	2900
1900	(M/D) Q190425W	(M/D) Q190425X	(M/D) Q190425Z	3100
2000	(M/D) Q200425W	(M/D) Q200425X	(M/D) Q200425Z	3295

SRB - S50 (Heavy Duty - Guillotine Single Blade Rock Bucket)

Single blade Heavy Duty SRB-S50 Bucket. Used for cutting medium-soft and medium-hard fractured rock formations; decompressed rock formations.

Teeth: 30 mm Shank
Body length: 1200 mm
Nom. length: 1800 mm

Ø	PART N°			Weight (kg)
	Kelly Box 130 x 130 mm	150 x 150 mm	200 x 200 mm	
600	(M/D) Q060450W	(M/D) Q060450X	(M/D) -	565
700	(M/D) Q070450W	(M/D) Q070450X	(M/D) -	750
800	(M/D) Q080450W	(M/D) Q080450X	(M/D) Q080450Z	930
900	(M/D) Q090450W	(M/D) Q090450X	(M/D) Q090450Z	1110
1000	(M/D) Q100450W	(M/D) Q100450X	(M/D) Q100450Z	1295
1100	(M/D) Q110450W	(M/D) Q110450X	(M/D) Q110450Z	1480
1200	(M/D) Q120450W	(M/D) Q120450X	(M/D) Q120450Z	1665
1300	(M/D) Q130450W	(M/D) Q130450X	(M/D) Q130450Z	1875
1400	(M/D) Q140450W	(M/D) Q140450X	(M/D) Q140450Z	2090
1500	(M/D) Q150450W	(M/D) Q150450X	(M/D) Q150450Z	2305
1600	(M/D) Q160450W	(M/D) Q160450X	(M/D) Q160450Z	2505
1700	(M/D) Q170450W	(M/D) Q170450X	(M/D) Q170450Z	2700
1800	(M/D) Q180450W	(M/D) Q180450X	(M/D) Q180450Z	2900
1900	(M/D) Q190450W	(M/D) Q190450X	(M/D) Q190450Z	3100
2000	(M/D) Q200450W	(M/D) Q200450X	(M/D) Q200450Z	3295



D type

BUCKETS

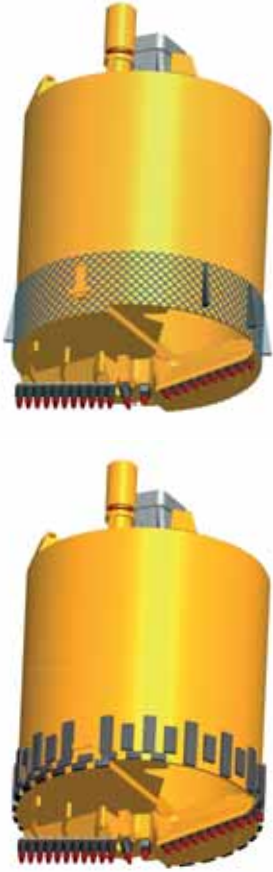

SRB - D35 (Heavy Duty - Guillotine Double Blade Rock Bucket)

Double blade Heavy Duty SRB-D35 Bucket. Used for cutting medium-soft low fractured rock formation combined with coarse soil; highly fractures hard rock formation and decompressed rock formations.

Teeth: 25 mm Shank
Body length: 1200 mm.
Nom. length: 1800 mm.

PART N°				
Ø	Kelly Box 130 x 130 mm	150 x 150 mm	200 x 200 mm	Weight (kg)
600	(M/D) Q060435W	(M/D)Q060435X	(M/D) Q060435Z	610
700	(M/D) Q070435W	(M/D)Q070435X	(M/D) Q070435Z	765
800	(M/D) Q080435W	(M/D)Q080435X	(M/D) Q080435Z	940
900	(M/D) Q090435W	(M/D)Q090435X	(M/D) Q090435Z	1110
1000	(M/D) Q100435W	(M/D)Q100435X	(M/D) Q100435Z	1285
1100	(M/D) Q110435W	(M/D)Q110435X	(M/D) Q110435Z	1470
1200	(M/D) Q120435W	(M/D)Q120435X	(M/D) Q120435Z	1650
1300	(M/D) Q130435W	(M/D)Q130435X	(M/D) Q130435Z	1865
1400	(M/D) Q140435W	(M/D)Q140435X	(M/D) Q140435Z	2085
1500	(M/D) Q150435W	(M/D)Q150435X	(M/D) Q150435Z	2290
1600	(M/D) Q160435W	(M/D)Q160435X	(M/D) Q160435Z	2490
1700	(M/D) Q170435W	(M/D)Q170435X	(M/D) Q170435Z	2685
1800	(M/D) Q180435W	(M/D)Q180435X	(M/D) Q180435Z	2880
1900	(M/D) Q190435W	(M/D)Q190435X	(M/D) Q190435Z	3075
2000	(M/D) Q200435W	(M/D)Q200435X	(M/D) Q200435Z	3275

SRB - D40 (Heavy Duty - Guillotine Double Blade Rock Bucket)

Double blade Heavy Duty SRB-D40 Bucket. Used for cutting medium-hard fractured rock formation combined with coarse soil; highly fractures hard rock formation and decompressed rock formations.

Teeth: 30 mm Shank
Body length: 1200 mm.
Nom. length: 1800 mm.

PART N°				
Ø	Kelly Box 130 x 130 mm	150 x 150 mm	200 x 200 mm	Weight (kg)
600	(M/D) Q060440W	(M/D) Q060440X	(M/D) Q060440Z	610
700	(M/D) Q070440W	(M/D) Q070440X	(M/D) Q070440Z	765
800	(M/D) Q080440W	(M/D) Q080440X	(M/D) Q080440Z	940
900	(M/D) Q090440W	(M/D) Q090440X	(M/D) Q090440Z	1110
1000	(M/D) Q100440W	(M/D) Q100440X	(M/D) Q100440Z	1285
1100	(M/D) Q110440W	(M/D) Q110440X	(M/D) Q110440Z	1470
1200	(M/D) Q120440W	(M/D) Q120440X	(M/D) Q120440Z	1650
1300	(M/D) Q130440W	(M/D) Q130440X	(M/D) Q130440Z	1865
1400	(M/D) Q140440W	(M/D) Q140440X	(M/D) Q140440Z	2085
1500	(M/D) Q150440W	(M/D) Q150440X	(M/D) Q150440Z	2290
1600	(M/D) Q160440W	(M/D) Q160440X	(M/D) Q160440Z	2490
1700	(M/D) Q170440W	(M/D) Q170440X	(M/D) Q170440Z	2685
1800	(M/D) Q180440W	(M/D) Q180440X	(M/D) Q180440Z	2880
1900	(M/D) Q190440W	(M/D) Q190440X	(M/D) Q190440Z	3075
2000	(M/D) Q200440W	(M/D) Q200440X	(M/D) Q200440Z	3275



CORE BARREL

SRC - 00 (Heavy Duty - Core Barrel)

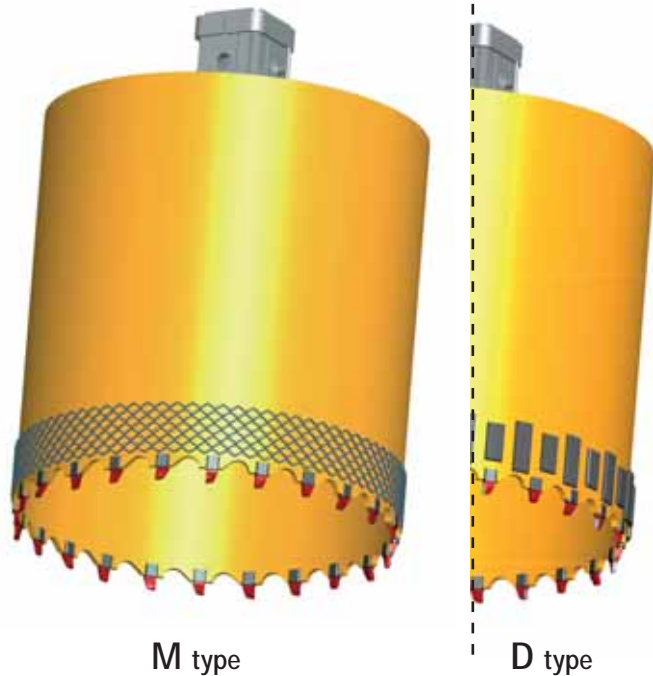

M type

D type

Heavy Duty SRC-00 Core barrel are built-in with radial tools. Generally used to cut low fractured medium hard rock formation and partially fragmented medium hard rock formations.

Teeth: Radial tools.
Body length: 1450 mm.

Ø	PART N°			Approx. Weight (kg)
	Kelly Box 130 x 130 mm	150 x 150 mm	200 x 200 mm	
600	(M/D) Q060200W	(M/D) Q060200X	(M/D) Q060200Z	475
700	(M/D) Q070200W	(M/D) Q070200X	(M/D) Q070200Z	560
800	(M/D) Q080200W	(M/D) Q080200X	(M/D) Q080200Z	650
900	(M/D) Q090200W	(M/D) Q090200X	(M/D) Q090200Z	730
1000	(M/D) Q100200W	(M/D) Q100200X	(M/D) Q100200Z	815
1100	(M/D) Q110200W	(M/D) Q110200X	(M/D) Q110200Z	895
1200	(M/D) Q120200W	(M/D) Q120200X	(M/D) Q120200Z	980
1300	(M/D) Q130200W	(M/D) Q130200X	(M/D) Q130200Z	1060
1400	(M/D) Q140200W	(M/D) Q140200X	(M/D) Q140200Z	1140
1500	(M/D) Q150200W	(M/D) Q150200X	(M/D) Q150200Z	1220
1600	(M/D) Q160200W	(M/D) Q160200X	(M/D) Q160200Z	1300
1700	(M/D) Q170200W	(M/D) Q170200X	(M/D) Q170200Z	1380
1800	(M/D) Q180200W	(M/D) Q180200X	(M/D) Q180200Z	1465
1900	(M/D) Q190200W	(M/D) Q190200X	(M/D) Q190200Z	1545
2000	(M/D) Q200200W	(M/D) Q200200X	(M/D) Q200200Z	1760

SRC - 10 (Heavy Duty - Core Barrel)

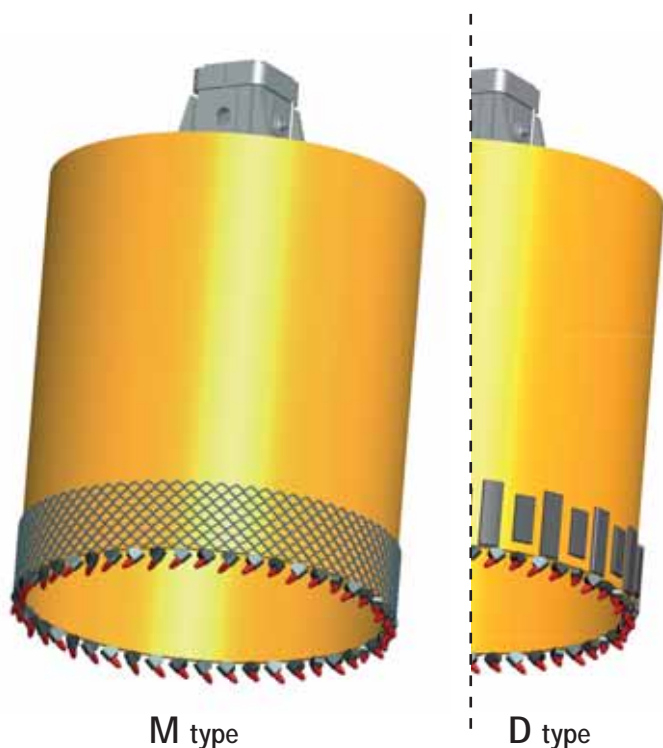

M type

D type

Heavy Duty SRC-10 Core barrel fitted with 19,4 mm round shank chisels tooth. Generally used to cut low fractured medium-soft rock formation to fractured medium-hard rocks formation.

Teeth: 19,4 mm Shank.
Body length: 1450 mm.

Ø	PART N°			Approx. Weight (kg)
	Kelly Box 130 x 130 mm	150 x 150 mm	200 x 200 mm	
600	(M/D) Q060210W	(M/D) Q060210X	(M/D) Q060210Z	505
700	(M/D) Q070210W	(M/D) Q070210X	(M/D) Q070210Z	590
800	(M/D) Q080210W	(M/D) Q080210X	(M/D) Q080210Z	680
900	(M/D) Q090210W	(M/D) Q090210X	(M/D) Q090210Z	760
1000	(M/D) Q100210W	(M/D) Q100210X	(M/D) Q100210Z	865
1100	(M/D) Q110210W	(M/D) Q110210X	(M/D) Q110210Z	945
1200	(M/D) Q120210W	(M/D) Q120210X	(M/D) Q120210Z	1030
1300	(M/D) Q130210W	(M/D) Q130210X	(M/D) Q130210Z	1110
1400	(M/D) Q140210W	(M/D) Q140210X	(M/D) Q140210Z	1190
1500	(M/D) Q150210W	(M/D) Q150210X	(M/D) Q150210Z	1280
1600	(M/D) Q160210W	(M/D) Q160210X	(M/D) Q160210Z	1360
1700	(M/D) Q170210W	(M/D) Q170210X	(M/D) Q170210Z	1450
1800	(M/D) Q180210W	(M/D) Q180210X	(M/D) Q180210Z	1515
1900	(M/D) Q190210W	(M/D) Q190210X	(M/D) Q190210Z	1615
2000	(M/D) Q200210W	(M/D) Q200210X	(M/D) Q200210Z	1830

CORE BARREL

SRC - 15 (Heavy Duty - Core Barrel)

Heavy Duty SRC-00 Core barrel are built-in with radial tools. Generally used to cut low fractured medium hard rock formation and partially fragmented medium hard rock formations.

Teeth: 25,4 mm shank.
Body length: 1450 mm.

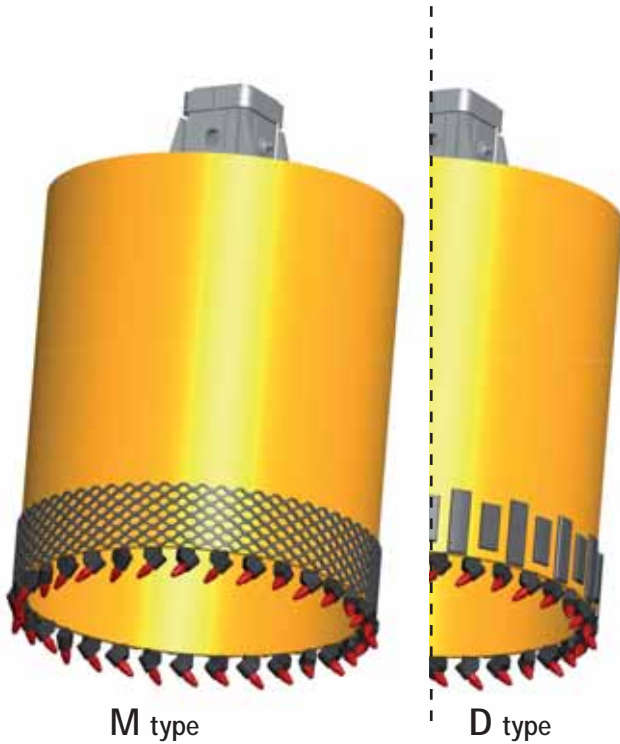

Ø	PART N°			Approx. Weight (kg)
	Kelly Box 130 x 130 mm	150 x 150 mm	200 x 200 mm	
600	(M/D) Q060215W	(M/D) Q060215X	(M/D) Q060215Z	505
700	(M/D) Q070215W	(M/D) Q070215X	(M/D) Q070215Z	590
800	(M/D) Q080215W	(M/D) Q080215X	(M/D) Q080215Z	680
900	(M/D) Q090215W	(M/D) Q090215X	(M/D) Q090215Z	760
1000	(M/D) Q100215W	(M/D) Q100215X	(M/D) Q100215Z	865
1100	(M/D) Q110215W	(M/D) Q110215X	(M/D) Q110215Z	945
1200	(M/D) Q120215W	(M/D) Q120215X	(M/D) Q120215Z	1030
1300	(M/D) Q130215W	(M/D) Q130215X	(M/D) Q130215Z	1110
1400	(M/D) Q140215W	(M/D) Q140215X	(M/D) Q140215Z	1190
1500	(M/D) Q150215W	(M/D) Q150215X	(M/D) Q150215Z	1280
1600	(M/D) Q160215W	(M/D) Q160215X	(M/D) Q160215Z	1360
1700	(M/D) Q170215W	(M/D) Q170215X	(M/D) Q170215Z	1450
1800	(M/D) Q180215W	(M/D) Q180215X	(M/D) Q180215Z	1515
1900	(M/D) Q190215W	(M/D) Q190215X	(M/D) Q190215Z	1615
2000	(M/D) Q200215W	(M/D) Q200215X	(M/D) Q200215Z	1830



CORE BARREL

SRC - 20 (Heavy Duty - Core Barrel)

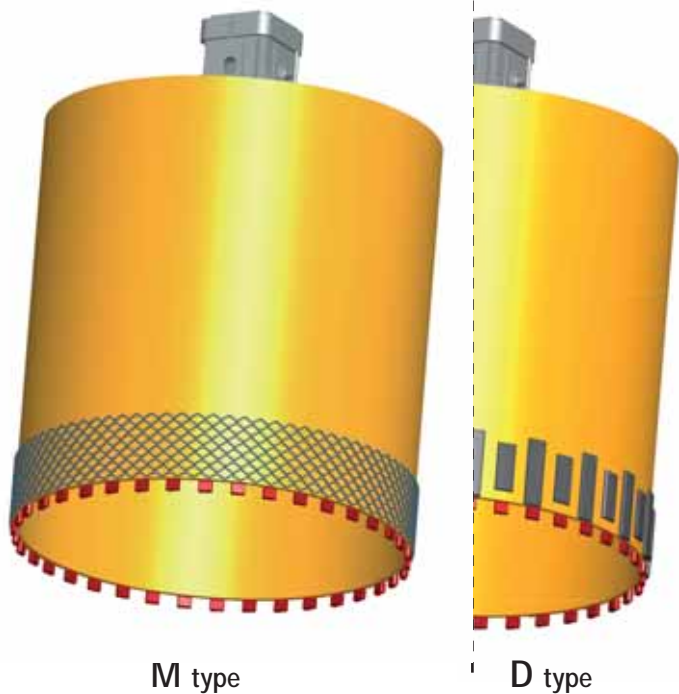

Heavy Duty SRC-20 Core barrel fitted with welding bars tooth. Generally used to cut low fractured medium and medium hard rock formation up to 80 MPa.

Teeth: Welding bars.
Body length: 1450 mm.

Ø	PART N°			Approx. Weight (kg)
	Kelly Box 130 x 130 mm	150 x 150 mm	200 x 200 mm	
600	(M/D) Q060220W	(M/D) Q060220X	(M/D) Q060220Z	465
700	(M/D) Q070220W	(M/D) Q070220X	(M/D) Q070220Z	550
800	(M/D) Q080220W	(M/D) Q080220X	(M/D) Q080220Z	640
900	(M/D) Q090220W	(M/D) Q090220X	(M/D) Q090220Z	720
1000	(M/D) Q100220W	(M/D) Q100220X	(M/D) Q100220Z	805
1100	(M/D) Q110220W	(M/D) Q110220X	(M/D) Q110220Z	885
1200	(M/D) Q120220W	(M/D) Q120220X	(M/D) Q120220Z	970
1300	(M/D) Q130220W	(M/D) Q130220X	(M/D) Q130220Z	1050
1400	(M/D) Q140220W	(M/D) Q140220X	(M/D) Q140220Z	1130
1500	(M/D) Q150220W	(M/D) Q150220X	(M/D) Q150220Z	1210
1600	(M/D) Q160220W	(M/D) Q160220X	(M/D) Q160220Z	1290
1700	(M/D) Q170220W	(M/D) Q170220X	(M/D) Q170220Z	1370
1800	(M/D) Q180220W	(M/D) Q180220X	(M/D) Q180220Z	1455
1900	(M/D) Q190220W	(M/D) Q190220X	(M/D) Q190220Z	1535
2000	(M/D) Q200220W	(M/D) Q200220X	(M/D) Q200220Z	1750

SRC - 30 (Heavy Duty - Core Barrel)

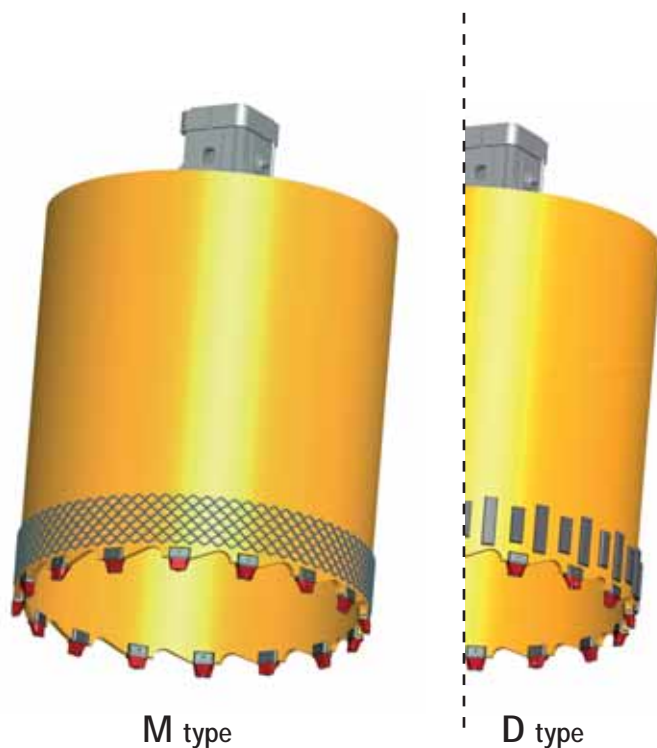

Heavy Duty SRC-30 Core barrel fitted with quick change bars tooth. Generally used to cut low fractured medium hard rock formation.

Teeth: Quick change bars.
Body length: 1450 mm.

Ø	PART N°			Approx. Weight (kg)
	Kelly Box 130 x 130 mm	150 x 150 mm	200 x 200 mm	
600	(M/D) Q060230W	(M/D) Q060230X	(M/D) Q060230Z	475
700	(M/D) Q070230W	(M/D) Q070230X	(M/D) Q070230Z	560
800	(M/D) Q080230W	(M/D) Q080230X	(M/D) Q080230Z	650
900	(M/D) Q090230W	(M/D) Q090230X	(M/D) Q090230Z	730
1000	(M/D) Q100230W	(M/D) Q100230X	(M/D) Q100230Z	815
1100	(M/D) Q110230W	(M/D) Q110230X	(M/D) Q110230Z	895
1200	(M/D) Q120230W	(M/D) Q120230X	(M/D) Q120230Z	980
1300	(M/D) Q130230W	(M/D) Q130230X	(M/D) Q130230Z	1060
1400	(M/D) Q140230W	(M/D) Q140230X	(M/D) Q140230Z	1140
1500	(M/D) Q150230W	(M/D) Q150230X	(M/D) Q150230Z	1220
1600	(M/D) Q160230W	(M/D) Q160230X	(M/D) Q160230Z	1300
1700	(M/D) Q170230W	(M/D) Q170230X	(M/D) Q170230Z	1380
1800	(M/D) Q180230W	(M/D) Q180230X	(M/D) Q180230Z	1465
1900	(M/D) Q190230W	(M/D) Q190230X	(M/D) Q190230Z	1545
2000	(M/D) Q200230W	(M/D) Q200230X	(M/D) Q200230Z	1760

CORE BARREL

SRC - 40 (Heavy Duty - Core Barrel)

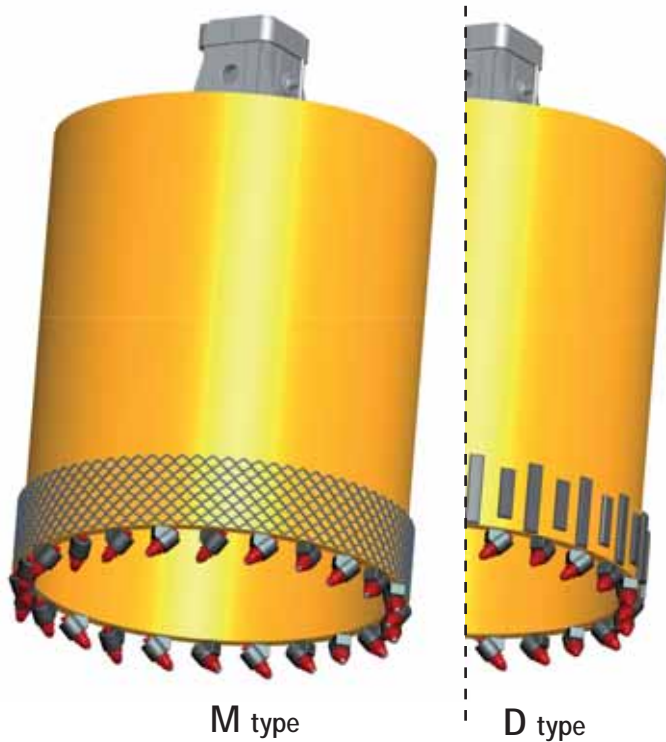

Heavy Duty SRC-40 Core barrel fitted with 30 mm round shank chisels tooth. Generally used to cut low fractured medium hard rock to fractured hard rock formation up to 80 MPa.

Teeth: 30 mm shank
Body length: 1450 mm.

Ø	PART N°			Approx. Weight (kg)	
	Kelly Box	130 x 130 mm	150 x 150 mm		200 x 200 mm
600	(M/D)	Q060240W	(M/D) Q060240X	(M/D) Q060240Z	665
700	(M/D)	Q070240W	(M/D) Q070240X	(M/D) Q070240Z	750
800	(M/D)	Q080240W	(M/D) Q080240X	(M/D) Q080240Z	840
900	(M/D)	Q090240W	(M/D) Q090240X	(M/D) Q090240Z	920
1000	(M/D)	Q100240W	(M/D) Q100240X	(M/D) Q100240Z	1025
1100	(M/D)	Q110240W	(M/D) Q110240X	(M/D) Q110240Z	1105
1200	(M/D)	Q120240W	(M/D) Q120240X	(M/D) Q120240Z	1190
1300	(M/D)	Q130240W	(M/D) Q130240X	(M/D) Q130240Z	1270
1400	(M/D)	Q140240W	(M/D) Q140240X	(M/D) Q140240Z	1350
1500	(M/D)	Q150240W	(M/D) Q150240X	(M/D) Q150240Z	1440
1600	(M/D)	Q160240W	(M/D) Q160240X	(M/D) Q160240Z	1520
1700	(M/D)	Q170240W	(M/D) Q170240X	(M/D) Q170240Z	1610
1800	(M/D)	Q180240W	(M/D) Q180240X	(M/D) Q180240Z	1675
1900	(M/D)	Q190240W	(M/D) Q190240X	(M/D) Q190240Z	1775
2000	(M/D)	Q200240W	(M/D) Q200240X	(M/D) Q200240Z	1930

SRC - 50 (Heavy Duty - Core Barrel)



Heavy Duty SRC-50 Core barrel fitted with roller cutters tooth. Generally used to cut low fractured hard rock formation up to 100 MPa.

Teeth: roller bit cutters
Body length: 1750 mm.

Ø	PART N°			Approx. Weight (kg)	
	Kelly Box	130 x 130 mm	150 x 150 mm		200 x 200 mm
600		DQ060250W	DQ060250X	DQ060250Z	805
700		DQ070250W	DQ070250X	DQ070250Z	890
800		DQ080250W	DQ080250X	DQ080250Z	980
900		DQ090250W	DQ090250X	DQ090250Z	1060
1000		DQ100250W	DQ100250X	DQ100250Z	1165
1100		DQ110250W	DQ110250X	DQ110250Z	1245
1200		DQ120250W	DQ120250X	DQ120250Z	1330
1300		DQ130250W	DQ130250X	DQ130250Z	1410
1400		DQ140250W	DQ140250X	DQ140250Z	1490
1500		DQ150250W	DQ150250X	DQ150250Z	1580
1600		DQ160250W	DQ160250X	DQ160250Z	1660
1700		DQ170250W	DQ170250X	DQ170250Z	1750
1800		DQ180250W	DQ180250X	DQ180250Z	1815
1900		DQ190250W	DQ190250X	DQ190250Z	1915
2000		DQ200250W	DQ200250X	DQ200250Z	2130



CONSUMABLES, KELLY BOX & SPARE PARTS

ESCO Super V Teeth



V-13	
Code N° teeth:	08720499
Code N° holder:	08720500
Code N° PIN:	08720283

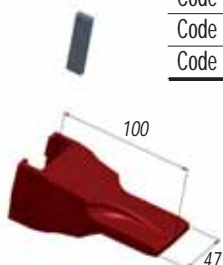

V-19	
Code N° teeth:	08720231
Code N° holder:	08720233
Code N° PIN:	08720237

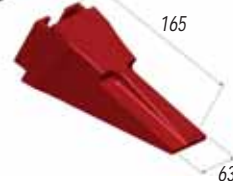

V-18	
Code N° teeth:	08720282
Code N° holder:	08720281
Code N° PIN:	08720283



V-23	
Code N° teeth:	08720234
Code N° holder:	08720236
Code N° PIN:	08720237

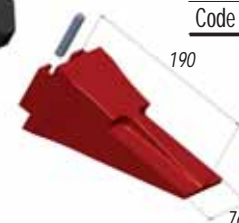

Flat Pick Teeth

Code N° teeth:	08721006
Code N° holder:	08721007

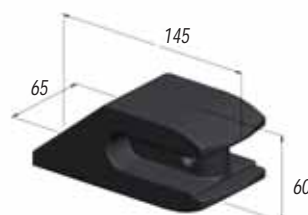
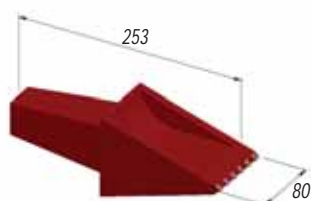
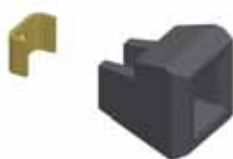

Code N° teeth:	08721008
Code N° holder:	08721009

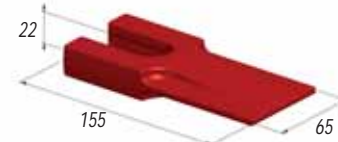

Code N° holder:	08721010
-----------------	----------

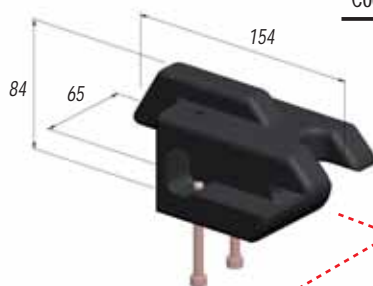

Code N° teeth:	08721013
----------------	----------

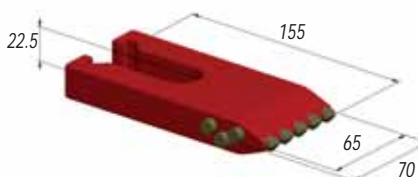

Code N° teeth:	08721011
----------------	----------



Code N° teeth:	08721012
----------------	----------

CONSUMABLES, KELLY BOX & SPARE PARTS

Core Barrel Teeth

Welding bars

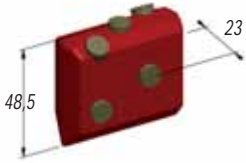

Code N° 0872166

Roller bit



Code N° tooth 08720273
Code N° holder 08720274

Radial tools

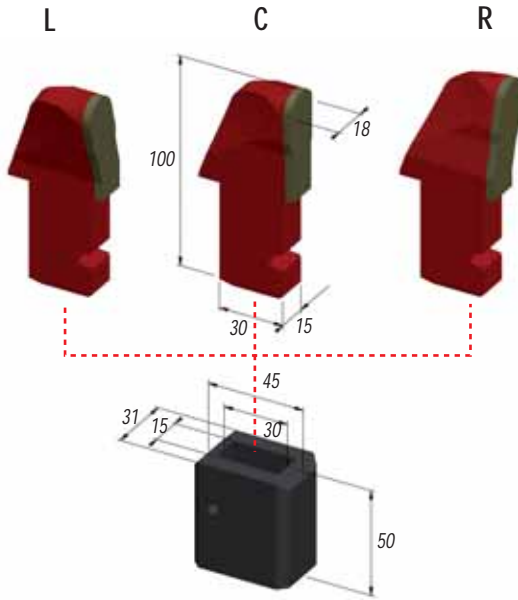

Code N° C. Tooth 08720307
Code N° L. Tooth 08720308
Code N° R. Tooth 08720309
Code N° Holder 08720310

Quick change bars

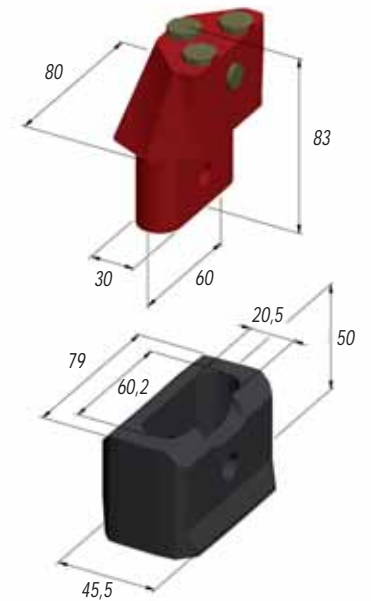

Code N° roller bit 08720945

Round Shank Picks

Code N° 08720239

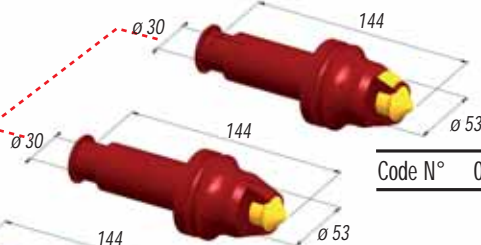

Code N° 08720994

Code N° 08720993

Code N° 08720238
(standard)

Code N° 08720992

Code N° 08720080

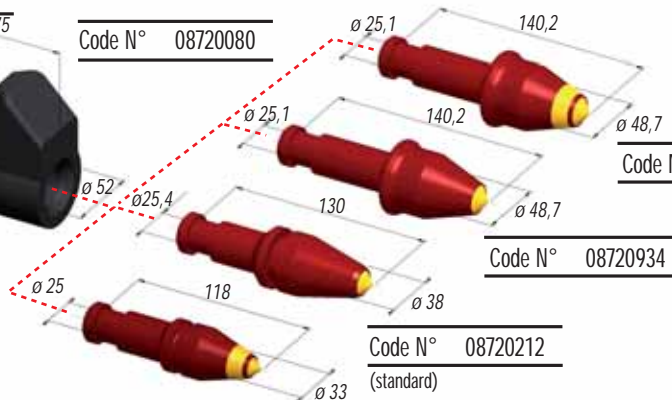

Code N° 08720933

Code N° 08720934

Code N° 08720212
(standard)

Code N° 08720935

Code N° 08720097

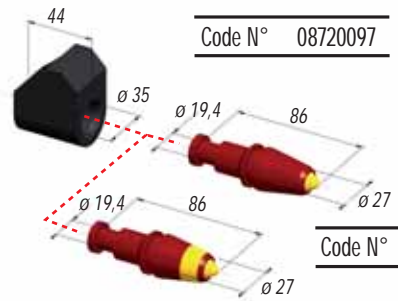

Code N° 08720136
(standard)

Code N° 08721023

CONSUMABLES, KELLY BOX & SPARE PARTS

Pilot Bits

with additional wearing protection

Code N° 02481000



Code N° 02481001



Code N° 02310404

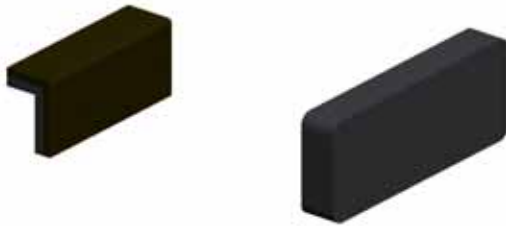

Code N° 02310403

kelly box & kelly box adapter

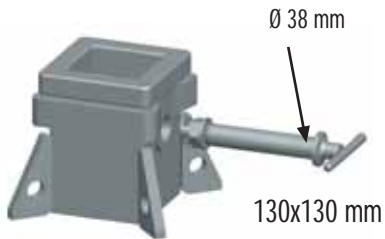

Code N° Box	08791059
Code N° PIN	02290028
Code N° stiffening bead:	08743703

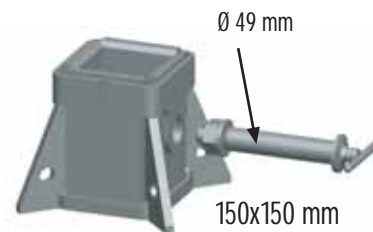

Code N° box	08791068
Code N° PIN	02290027
Code N° stiffening bead:	08743704

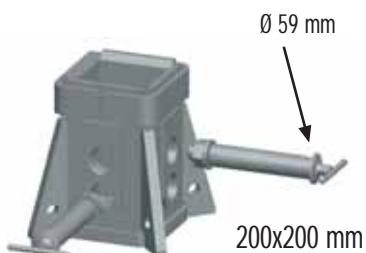

Code N° box	08791067
Code N° PIN	02290042
Code N° stiffening bead:	08743727











Fm x MI.	
130x150 Adaptor	Code N° 02290036
130x200 Adaptor	Code N° 02290034
150x130 Adaptor	Code N° 02290035
150x200 Adaptor	Code N° 02290038
200x130 Adaptor	Code N° 02290052
200x150 Adaptor	Code N° 02290045

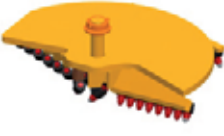



Fm = Female size in mm.
MI = Male size in mm.







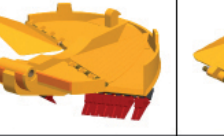
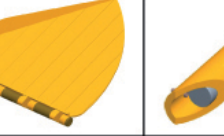
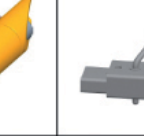
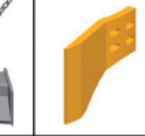

PARTS







		SPRING	OPENING SYSTEM	OPENING BOTTOM	REVOLVING BOTTOM	HINGE		
BUCKET SSB - S25 AND S50 HEAVY DUTY - GUILLOTINE SINGLE BLADE ROCK BUCKET								
Ø600	MQ060425	40630001	02310109	02310237	02310252	02310171		
Ø700	MQ070425	40630001	02310109	02310238	02310253	02310172		
Ø800	MQ080425	40630001	02310109	02310239	02310254	02310172		
Ø900	MQ090425	40630001	02310110	02310240	02310255	02310173		
Ø1000	MQ100425	40630113	02310111	02310241	02310256	02310173		
Ø1100	MQ110425	40630113	02310112	02310242	02310257	02310173		
Ø1200	MQ120425	40630113	02310113	02310243	02310258	02310174		
Ø1300	MQ130425	40630113	02310114	02310244	02310259	02310174		
Ø1400	MQ140425	40630113	02310115	02310245	02310260	02310174		
Ø1500	MQ150425	40630113	02310116	02310246	02310261	02310175		
Ø1600	MQ160425	40630113	02310117	02310247	02310262	02310175		
Ø1700	MQ170425	40630113	02310118	02310248	02310263	02310175		
Ø1800	MQ180425	40630113	02310119	02310249	02310264	02310176		
Ø1900	MQ190425	40630113	02310120	02310250	02310265	02310176		
Ø2000	MQ200425	40630113	02310121	02310251	02310266	02310176		





		SPRING	OPENING SYSTEM	BOTTOM	FLAP VALVE	HINGE		
BUCKET SSB - D05 HEAVY DUTY - DOUBLE BLADE ROCK BUCKET								
Ø600	MQ060405	40630001	02310107	02310297	02310126	02310171		
Ø700	MQ070405	40630001	02310108	02310298	02310127	02310172		
Ø800	MQ080405	40630001	02310109	02310299	02310128	02310172		
Ø900	MQ090405	40630001	02310110	02310300	02310129	02310173		
Ø1000	MQ100405	40630113	02310111	02310301	02310130	02310173		
Ø1100	MQ110405	40630113	02310112	02310302	02310131	02310173		
Ø1200	MQ120405	40630113	02310113	02310303	02310132	02310174		
Ø1300	MQ130405	40630113	02310114	02310304	02310133	02310174		
Ø1400	MQ140405	40630113	02310115	02310305	02310134	02310174		
Ø1500	MQ150405	40630113	02310116	02310306	02310135	02310175		
Ø1600	MQ160405	40630113	02310117	02310307	02310136	02310175		
Ø1700	MQ170405	40630113	02310118	02310308	02310137	02310175		
Ø1800	MQ180405	40630113	02310119	02310309	02310138	02310176		
Ø1900	MQ190405	40630113	02310120	02310310	02310139	02310176		
Ø2000	MQ200405	40630113	02310121	02310311	02310140	02310176		

		SPRING	OPENING SYSTEM	BOTTOM	FLAP VALVE	HINGE	UPPER REAMER	LOWER REAMER	PILOT BIT
BUCKET SSB - CN60 HEAVY DUTY CONICAL BOTTOM BUCKET									
Ø600	MH060460	40630001	02310107	02310342	02310357	02310171	02310122	02310405	02310383
Ø700	MH070460	40630001	02310108	02310343	02310358	02310172	02310122	02310406	02310383
Ø800	MH080460	40630001	02310109	02310344	02310359	02310172	02310123	02310407	02310383
Ø900	MH090460	40630001	02310110	02310345	02310360	02310173	02310123	02310408	02310383
Ø1000	MH100460	40630113	02310111	02310346	02310361	02310173	02310124	02310409	02310383
Ø1100	MH110460	40630113	02310112	02310347	02310362	02310173	02310124	02310410	02310383
Ø1200	MH120460	40630113	02310113	02310348	02310363	02310174	02310125	02310411	02310383
Ø1300	MH130460	40630113	02310114	02310349	02310364	02310174	02310125	02310412	02310383
Ø1400	MH140460	40630113	02310115	02310350	02310365	02310174	02310125	02310413	02310383
Ø1500	MH150460	40630113	02310116	02310351	02310366	02310175	02310125	02310414	02310383
Ø1600	MH160460	40630113	02310117	02310352	02310367	02310175	02310125	02310415	02310383
Ø1700	MH170460	40630113	02310118	02310353	02310368	02310175	02310125	02310416	02310383
Ø1800	MH180460	40630113	02310119	02310354	02310369	02310176	02310125	02310417	02310383
Ø1900	MH190460	40630113	02310120	02310355	02310370	02310176	02310125	02310418	02310383
Ø2000	MH200460	40630113	02310121	02310356	02310371	02310176	02310125	02310419	02310383





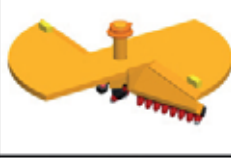

PARTS







BUCKET SSB - HDS HEAVY DUTY BUCKET		SPRING	OPENING SYSTEM	BOTTOM	FLAP VALVE	HINGE	UPPER REAMER	LOWER REAMER
								
Ø600	MH060405	40630001	02310107	02310156	02310126	02310171	02310122	02310405
Ø700	MH070405	40630001	02310108	02310157	02310127	02310172	02310122	02310406
Ø800	MH080405	40630001	02310109	02310158	02310128	02310172	02310123	02310407
Ø900	MH090405	40630001	02310110	02310159	02310129	02310173	02310123	02310408
Ø1000	MH100405	40630113	02310111	02310160	02310130	02310173	02310124	02310409
Ø1100	MH110405	40630113	02310112	02310161	02310131	02310173	02310124	02310410
Ø1200	MH120405	40630113	02310113	02310162	02310132	02310174	02310125	02310411
Ø1300	MH130405	40630113	02310114	02310163	02310133	02310174	02310125	02310412
Ø1400	MH140405	40630113	02310115	02310164	02310134	02310174	02310125	02310413
Ø1500	MH150405	40630113	02310116	02310165	02310135	02310175	02310125	02310414
Ø1600	MH160405	40630113	02310117	02310166	02310136	02310175	02310125	02310415
Ø1700	MH170405	40630113	02310118	02310167	02310137	02310175	02310125	02310416
Ø1800	MH180405	40630113	02310119	02310168	02310138	02310176	02310125	02310417
Ø1900	MH190405	40630113	02310120	02310169	02310139	02310176	02310125	02310418
Ø2000	MH200405	40630113	02310121	02310170	02310140	02310176	02310125	02310419







BUCKET SSB - G25 GUILLOTINE BUCKET		SPRING	OPENING SYSTEM	OPENING BOTTOM	REVOLVING BOTTOM	HINGE	UPPER REAMER	
								
Ø600	MZ060425	40630001	02310107	02310177	02310207	02310171	02310122	
Ø700	MZ070425	40630001	02310108	02310178	02310208	02310172	02310122	
Ø800	MZ080425	40630001	02310109	02310179	02310209	02310172	02310123	
Ø900	MZ090425	40630001	02310110	02310180	02310210	02310173	02310123	
Ø1000	MZ100425	40630113	02310111	02310181	02310211	02310173	02310124	
Ø1100	MZ110425	40630113	02310112	02310182	02310212	02310173	02310124	
Ø1200	MZ120425	40630113	02310113	02310183	02310213	02310174	02310125	
Ø1300	MZ130425	40630113	02310114	02310184	02310214	02310174	02310125	
Ø1400	MZ140425	40630113	02310115	02310185	02310215	02310174	02310125	
Ø1500	MZ150425	40630113	02310116	02310186	02310216	02310175	02310125	
Ø1600	MZ160425	40630113	02310117	02310187	02310217	02310175	02310125	
Ø1700	MZ170425	40630113	02310118	02310188	02310218	02310175	02310125	
Ø1800	MZ180425	40630113	02310119	02310189	02310219	02310176	02310125	
Ø1900	MZ190425	40630113	02310120	02310190	02310220	02310176	02310125	
Ø2000	MZ200425	40630113	02310121	02310191	02310221	02310176	02310125	

BUCKET SB - D35 AND D40 HEAVY DUTY - GUILLOTINE DOUBLE BLADE ROCK BUCKET		SPRING	OPENING SYSTEM	OPENING BOTTOM	REVOLVING BOTTOM	HINGE		
								
Ø600	MQ060435	40630001	02310107	02310267	02310282	02310171		
Ø700	MQ070435	40630001	02310108	02310268	02310283	02310172		
Ø800	MQ080435	40630001	02310109	02310269	02310284	02310172		
Ø900	MQ090435	40630001	02310110	02310270	02310285	02310173		
Ø1000	MQ100435	40630113	02310111	02310271	02310286	02310173		
Ø1100	MQ110435	40630113	02310112	02310272	02310287	02310173		
Ø1200	MQ120435	40630113	02310113	02310273	02310288	02310174		
Ø1300	MQ130435	40630113	02310114	02310274	02310289	02310174		
Ø1400	MQ140435	40630113	02310115	02310275	02310290	02310174		
Ø1500	MQ150435	40630113	02310116	02310276	02310291	02310175		
Ø1600	MQ160435	40630113	02310117	02310277	02310292	02310175		
Ø1700	MQ170435	40630113	02310118	02310278	02310293	02310175		
Ø1800	MQ180435	40630113	02310119	02310279	02310294	02310176		
Ø1900	MQ190435	40630113	02310120	02310280	02310295	02310176		
Ø2000	MQ200435	40630113	02310121	02310281	02310296	02310176		







PARTS



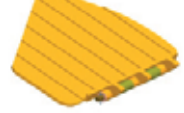

BUCKET SSB - CLOS CLEANING BUCKET		SPRING	OPENING SYSTEM	BOTTOM	FLAP VALVE	HINGE	BLADE	
			 dia = 1300 dia = 1400					
Ø600	MC060405	40630001	02310107	02310312	02310126	02310171	02310385	
Ø700	MC070405	40630001	02310108	02310313	02310127	02310172	02310386	
Ø800	MC080405	40630001	02310109	02310314	02310128	02310172	02310387	
Ø900	MC090405	40630001	02310110	02310315	02310129	02310173	02310388	
Ø1000	MC100405	40630113	02310111	02310316	02310130	02310173	02310389	
Ø1100	MC110405	40630113	02310112	02310317	02310131	02310173	02310390	
Ø1200	MC120405	40630113	02310113	02310318	02310132	02310174	02310391	
Ø1300	MC130405	40630113	02310114	02310319	02310133	02310174	02310392	
Ø1400	MC140405	40630113	02310115	02310320	02310134	02310174	02310393	
Ø1500	MC150405	40630113	02310116	02310321	02310135	02310175	02310394	
Ø1600	MC160405	40630113	02310117	02310322	02310136	02310175	02310395	
Ø1700	MC170405	40630113	02310118	02310323	02310137	02310175	02310396	
Ø1800	MC180405	40630113	02310119	02310324	02310138	02310176	02310397	
Ø1900	MC190405	40630113	02310120	02310325	02310139	02310176	02310398	
Ø2000	MC200405	40630113	02310121	02310326	02310140	02310176	02310399	

BUCKET SSB - GCL25 GUILLotine CLEANING BUCKET		SPRING	OPENING SYSTEM	OPENING BOTTOM	REVOLVING BOTTOM	HINGE	BLADE	
			 dia = 1300 dia = 1400					
Ø600	MC060425	40630001	02310107	02310177	02310327	02310171	02310385	
Ø700	MC070425	40630001	02310108	02310178	02310328	02310172	02310386	
Ø800	MC080425	40630001	02310109	02310179	02310329	02310172	02310387	
Ø900	MC090425	40630001	02310110	02310180	02310330	02310173	02310388	
Ø1000	MC100425	40630113	02310111	02310181	02310331	02310173	02310389	
Ø1100	MC110425	40630113	02310112	02310182	02310332	02310173	02310390	
Ø1200	MC120425	40630113	02310113	02310183	02310333	02310174	02310391	
Ø1300	MC130425	40630113	02310114	02310184	02310334	02310174	02310392	
Ø1400	MC140425	40630113	02310115	02310185	02310335	02310174	02310393	
Ø1500	MC150425	40630113	02310116	02310186	02310336	02310175	02310394	
Ø1600	MC160425	40630113	02310117	02310187	02310337	02310175	02310395	
Ø1700	MC170425	40630113	02310118	02310188	02310338	02310175	02310396	
Ø1800	MC180425	40630113	02310119	02310189	02310339	02310176	02310397	
Ø1900	MC190425	40630113	02310120	02310190	02310340	02310176	02310398	
Ø2000	MC200425	40630113	02310121	02310191	02310341	02310176	02310399	

BUCKET SSB - LW30 COMPACT GUILLotine BUCKET		SPRING	OPENING SYSTEM	OPENING BOTTOM	REVOLVING BOTTOM	HINGE	UPPER REAMER	
			 dia = 1300 dia = 1400					
Ø600	MZ060430	40630001	02311100	02310177	02310207	02310171	02310122	
Ø700	MZ070430	40630001	02311101	02310178	02310208	02310172	02310122	
Ø800	MZ080430	40630001	02311102	02310179	02310209	02310172	02310123	
Ø900	MZ090430	40630001	02311103	02310180	02310210	02310173	02310123	
Ø1000	MZ100430	40630113	02311104	02310181	02310211	02310173	02310124	
Ø1100	MZ110430	40630113	02311105	02310182	02310212	02310173	02310124	
Ø1200	MZ120430	40630113	02311106	02310183	02310213	02310174	02310125	
Ø1300	MZ130430	40630113	02311107	02310184	02310214	02310174	02310125	
Ø1400	MZ140430	40630113	02311108	02310185	02310215	02310174	02310125	
Ø1500	MZ150430	40630113	02311109	02310186	02310216	02310175	02310125	
Ø1600	MZ160430	40630113	02311110	02310187	02310217	02310175	02310125	
Ø1700	MZ170430	40630113	02311111	02310188	02310218	02310175	02310125	
Ø1800	MZ180430	40630113	02311112	02310189	02310219	02310176	02310125	
Ø1900	MZ190430	40630113	02311113	02310190	02310220	02310176	02310125	
Ø2000	MZ200430	40630113	02311114	02310191	02310221	02310176	02310125	

PARTS

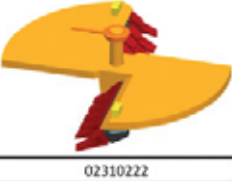
		SPRING	OPENING SYSTEM	BOTTOM	FLAP VALVE	HINGE	UPPER REAMER	LOWER REAMER
								
BUCKET 5SB - 05	BUCKET		8mm x 1300 6mm x 1400					
Ø600	MZ060405	40630001	02310107	02310141	02310126	02310171	02310122	02310405
Ø700	MZ070405	40630001	02310108	02310142	02310127	02310172	02310122	02310406
Ø800	MZ080405	40630001	02310109	02310143	02310128	02310172	02310123	02310407
Ø900	MZ090405	40630001	02310110	02310144	02310129	02310173	02310123	02310408
Ø1000	MZ100405	40630113	02310111	02310145	02310130	02310173	02310124	02310409
Ø1100	MZ110405	40630113	02310112	02310146	02310131	02310173	02310124	02310410
Ø1200	MZ120405	40630113	02310113	02310147	02310132	02310174	02310125	02310411
Ø1300	MZ130405	40630113	02310114	02310148	02310133	02310174	02310125	02310412
Ø1400	MZ140405	40630113	02310115	02310149	02310134	02310174	02310125	02310413
Ø1500	MZ150405	40630113	02310116	02310150	02310135	02310175	02310125	02310414
Ø1600	MZ160405	40630113	02310117	02310151	02310136	02310175	02310125	02310415
Ø1700	MZ170405	40630113	02310118	02310152	02310137	02310175	02310125	02310416
Ø1800	MZ180405	40630113	02310119	02310153	02310138	02310176	02310125	02310417
Ø1900	MZ190405	40630113	02310120	02310154	02310139	02310176	02310125	02310418
Ø2000	MZ200405	40630113	02310121	02310155	02310140	02310176	02310125	02310419

		SPRING	OPENING SYSTEM	OPENING BOTTOM	REVOLVING BOTTOM	HINGE	UPPER REAMER	
								
BUCKET 5SB - GH25	HEAVY DUTY GUILLOTINE BUCKET		8mm x 1300 6mm x 1400					
Ø600	MH060425	40630001	02310107	02310192	02310222	02310171	02310122	
Ø700	MH070425	40630001	02310108	02310193	02310223	02310172	02310122	
Ø800	MH080425	40630001	02310109	02310194	02310224	02310172	02310123	
Ø900	MH090425	40630001	02310110	02310195	02310225	02310173	02310123	
Ø1000	MH100425	40630113	02310111	02310196	02310226	02310173	02310124	
Ø1100	MH110425	40630113	02310112	02310197	02310227	02310173	02310124	
Ø1200	MH120425	40630113	02310113	02310198	02310228	02310174	02310125	
Ø1300	MH130425	40630113	02310114	02310199	02310229	02310174	02310125	
Ø1400	MH140425	40630113	02310115	02310200	02310230	02310174	02310125	
Ø1500	MH150425	40630113	02310116	02310201	02310231	02310175	02310125	
Ø1600	MH160425	40630113	02310117	02310202	02310232	02310175	02310125	
Ø1700	MH170425	40630113	02310118	02310203	02310233	02310175	02310125	
Ø1800	MH180425	40630113	02310119	02310204	02310234	02310176	02310125	
Ø1900	MH190425	40630113	02310120	02310205	02310235	02310176	02310125	
Ø2000	MH200425	40630113	02310121	02310206	02310236	02310176	02310125	

All technical data are purely indicative and subject to change without notice

© 2010 SOILMEC - 1000 - N - Litografia CILS Cesena - Il Digitale



SOILMEC distributes machinery and structures all over the world, supported by SOILMEC subsidiary companies and dealers. The complete Soilmec network list is available on the webpage www.soilmec.it

www.soilmec.it

soilmec 
Drilling and Foundation Equipment